

RURAL MUNICIPALITY OF LAKESHORE BY-LAW NO. 01-2023

A by-law of the Rural Municipality of Lakeshore to regulate the use and development of land.

WHEREAS, Section 68 of *The Planning Act* requires a municipality to adopt a zoning by-law that is generally consistent with the development plan by-law in effect in the municipality;

AND WHEREAS, under Part 4 Division 1 of *The Planning Act*, the Lakeshore Planning District has, by by-law, adopted the *Lakeshore Planning District Development Plan*;

NOW THEREFORE, the Council of the Rural Municipality of Lakeshore in meeting duly assembled, enacts as follows:

The Zoning By-law No. 01-2023 attached is hereby adopted.

The By-law shall be known as the Rural Municipality of Lakeshore Zoning By-law.

By-laws 02-2022 and 13-01, as amended, are repealed.

This By-law shall come into force on March 28, 2023.

DONE AND PASSED in Council duly assembled at the Rural Municipality of Lakeshore, Manitoba, this 28th day of March, 2023.

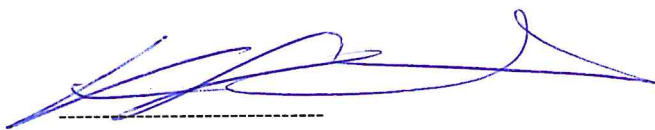

Clayton Watts, Reeve

Kevin Drewniak, Chief Administrative Officer

READ A FIRST TIME this 10th day of January, 2023.

READ A SECOND TIME this 14th day of March, 2023.

READ A THIRD TIME this 28th day of March, 2023.

**RURAL MUNICIPALITY OF LAKESHORE
ZONING BY-LAW**

By-law No. 01-2023

HOW TO USE THIS ZONING BY-LAW

This Zoning By-law regulates the use, size, height, and location of buildings on properties within the Municipality. There is a simple four-step process to determine the uses and structures that are permitted on a specific piece of property.

STEP ONE WHAT ZONE IS YOUR PROPERTY LOCATED IN?

- Use the Zoning Map in [Schedule A](#) to determine the zoning for your property.
- Reference [Part 3: Zones](#) for a description of the intent of that particular zone.
- Look in the Development Plan and any Secondary Plan that applies to your property to confirm your proposal fits with the applicable policies in those documents.

STEP TWO WHAT USES ARE PERMITTED IN YOUR ZONE?

- Find the column with the zone of your property in the Use Table in [Part 3: Zones](#).
- Uses marked with the letter P are permitted uses and may be developed once you have received a development permit.
- Uses marked with the letter C are conditional uses that may or may not be acceptable in a zone depending on the particular circumstances of a proposed development. Conditional uses require a public hearing process and may have extra conditions imposed on the use to make it acceptable for the location. Uses not listed in the table will require an amendment to the Zoning By-law.
- Uses marked with use-specific requirements are provided in [Part 4: Use-Specific Standards](#).

STEP THREE HOW AND WHERE CAN YOU DEVELOP PROPERTIES IN YOUR ZONE?

- Find the column with the zone of your property in the Dimensional Standards Table in [Part 3: Zones](#).
- The Dimensional Standards Table provides information on allowable height of buildings and structures, required yards, and other spatial requirements for a property.
- To understand the specific details of these requirements, you may need to reference [Part 2: General Regulations](#) and [Part 6: Definitions](#).

STEP FOUR WHAT KIND OF PERMITS DO YOU NEED?

- In most cases, you will need a development permit before you start any change in land use or any development (including construction of a building, demolition, additions, major landscaping) on a property.
- Check [Part 5: Administration](#) to see if your planned development is exempt from needing a development permit. If so, you may proceed with development, as long as it meets the other requirements in this By-law and other applicable by-laws.
- If you need a development permit, fill out a permit application.
- You are responsible for finding out any other provincial or federal regulations applying to your development, as well as any other required local permits, including building permits.

HOW TO USE THIS ZONING BY-LAW I

PART 1: APPLICABILITY AND SCOPE 1

1.1 Title 1

1.2 Scope..... 1

1.3 Application 1

1.4 Intent 1

1.5 Use and Development of Land and Buildings Must Comply..... 1

1.6 Restrictions in Other By-laws or Federal and Provincial Laws..... 1

1.7 Does Not Promote Nuisance..... 2

1.8 Rules of Interpretation..... 2

1.9 Public Utilities 2

PART 2: GENERAL REGULATIONS 3

2.1 Regulation of Uses 3

2.2 Multiple Uses or Provisions 3

2.3 Accessory Uses and Structures 3

2.4 Temporary Buildings, Structures, or Uses..... 4

2.5 Number of Buildings Permitted Per Site..... 4

2.6 Separation of Principal Building and Any Other Building 4

2.7 Service Connections..... 4

2.8 Noxious or Offensive Uses 4

2.9 Storage of Automobiles, Parts or Machinery..... 4

2.10 Projections in Required Yards..... 5

2.11 Height Exception 5

2.12 Fences 5

2.13 Roads and Highways 7

2.14 Railways 7

2.15 Public Aircraft Landing Areas 7

2.16 Parking 8

2.17 Signs 9

2.18 Subdivisions 10

2.19 Site Areas and Yards 11

2.20 Corner Vision Triangles 13

2.21 Hazard Lands..... 13

2.22 Building Grade and Flooding..... 13

2.23 Riparian and Wetland Areas 14

2.24 Monuments and Statuaries 14

2.25 Building Removal 14

PART 3: ZONES 15

3.1 Establishing Zones..... 15

3.2 Permitted and Conditional Uses 15

3.3 Accessory Buildings and structures..... 18

3.4 Temporary Uses, Buildings and Structures 19

3.5 Dimensional Standards 19

3.6 Special Dimensional standards 23

PART 4: USE-SPECIFIC STANDARDS 24

4.1 Mutual Separation Distances..... 24

4.2 Apiary (Beekeeping)..... 24

4.3 Bed and Breakfast.....	25
4.4 Camping and Tenting Grounds	25
4.5 Cannabis Sales.....	25
4.6 Community Garden.....	25
4.7 Detached Garage	25
4.8 Dwelling, Cottage.....	26
4.9 Dwelling	26
4.10 Home Industry	26
4.11 Home-Based Business.....	27
4.12 Livestock Operations.....	27
4.13 Mining and Extraction.....	31
4.14 Mobile/Manufactured Homes	32
4.15 Mobile/Manufactured Home Park.....	32
4.16 Portable Garages.....	33
4.17 Secondary Suites	33
4.18 Service Stations.....	33
4.19 Shipping Container.....	34
4.20 Solar Collector	34
4.21 Swimming Pools and Hot Tubs.....	34
4.22 Wind Energy Generating System Tower (Commercial)	35
4.23 Wind Energy Generating Systems (On-Site / Rooftop)	35
PART 5: ADMINISTRATION	36
5.1 Administration and Enforcement	36
5.2 The Development Officer.....	36
5.3 Roles of the Designated Officer	36
5.4 Development Permits	36
5.5 Variances.....	38
5.6 Conditional Use.....	38
5.7 Zoning Memoranda	39
5.8 Applications	39
5.9 Development Agreement	39
5.10 Non-Conformity	40
PART 6: DEFINITIONS	41
6.1 Definitions in The Planning Act.....	41
6.2 Definitions in this By-law	41
SCHEDULE A: ZONING MAPS.....	53

PART 1: APPLICABILITY AND SCOPE

1.1 TITLE

This By-law shall be known as the Rural Municipality of Lakeshore Zoning By-law.

1.2 SCOPE

This By-law applies to all lands in the Municipality as indicated on Map 1 of Schedule A of this By-law.

1.3 APPLICATION

This By-law regulates:

- a) The construction, erection, alteration, enlargement or placing of buildings and structures.
- b) The establishment, alteration, or enlargement of uses of land, buildings, and structures.
- c) All other forms of development not included above.

1.4 INTENT

The regulations and provisions established by this By-Law are deemed necessary in order to:

- a) Implement the objectives and policies of the *Lakeshore Planning District Development Plan*.
- b) Define the powers and duties of the Council and Designated Officers in accordance with *The Planning Act*.
- c) Regulate the following:
 - (i) All new buildings and structures.
 - (ii) All alterations, demolitions or relocations of existing buildings and structures.
 - (iii) All enlargements of existing buildings, structures or uses.
 - (iv) All changes in the use or intensity of use of buildings, structures, and land.

1.5 USE AND DEVELOPMENT OF LAND AND BUILDINGS MUST COMPLY

Within the Municipality, no land, building or structure shall be used or occupied, and no building or structure shall be constructed, erected, altered, enlarged, or placed, except in accordance with this By-law.

1.6 RESTRICTIONS IN OTHER BY-LAWS OR FEDERAL AND PROVINCIAL LAWS

Whenever a provision of another by-law or a law or regulation of the provincial or federal government contains a restriction governing the same subject matter contained in this By-law, or imposes inconsistent regulations with respect to uses, buildings, or structures, the most restrictive or highest standard shall prevail.

1.7 DOES NOT PROMOTE NUISANCE

Nothing in this By-law or in a development permit, approval of a conditional use, variance order or other approval issued under this By-law shall be construed as authorization for the carrying out of any activity which is a nuisance due to noise, odour, emission, vibration, or other cause.

1.8 RULES OF INTERPRETATION

The following rules of interpretation shall apply to the text of this By-law:

- a) Words, phrases, and terms defined in this By-Law shall be given the defined meaning.
- b) Words, phrases, and terms not defined in this By-law but defined in The Act or in the Building, Electrical or Plumbing By-laws of the Municipality shall be construed as defined in such Act and By-laws.
- c) Words, phrases, and terms neither defined in this By-law nor in The Act, or the Building By-law of the Municipality shall be given their usual and customary meaning except where the context clearly indicates a different meaning.
- d) Where any requirement of this By-law results in a fraction of a unit, a fraction of five tenths (5/10) or more shall be considered a whole unit and a fraction of less than five tenths (5/10) shall be disregarded.
- e) The words “shall” and “must” are mandatory and not permissive; the word “may” is permissive and not mandatory.
- f) Words used in the singular include the plural and words used in the plural include the singular.
- g) Words used in the present tense include the future tense and words used in the future tense include the present tense.
- h) The phrase “used for” includes “arranged for”, “designed for”, “maintained for” or “occupied for”.
- i) The words “person” includes an individual, a corporation, a partnership, an incorporated association, or any other similar entity.
- j) Unless the context clearly indicates the contrary, where a regulation involves two or more items, conditions, provisions, or events connected by the conjunction “and”, “or”, “either-or”, the conjunction shall be interpreted as follows:
 - (i) “And” indicates that all the connected items, conditions, provisions, or events shall apply in any combination.
 - (ii) “Or” indicates that the connected items, conditions, provisions, or events may apply singly or in any combination.
 - (iii) “Either-or” indicates that the connected items, conditions, provisions, or events shall apply singly but not in combination.
- k) The words “include” “includes” or “including” shall not limit a term to the specified examples, but is intended to extend the meaning to all other instances or circumstances of like kind or character.

1.9 PUBLIC UTILITIES

This By-law shall be interpreted so as not to interfere with the construction, erection and location of a public utility’s works, plant, pipes, cables, or equipment.

PART 2: GENERAL REGULATIONS

The following regulations shall apply to all use and development of land and buildings in the Municipality, except where otherwise noted in this By-law.

2.1 REGULATION OF USES

No land, building or structure shall be used or occupied except for a use which:

- a) Is listed in the Use Table in Part 3 as:
 - (i) A Permitted Principal Use.
 - (ii) A Permitted Accessory Use.
 - (iii) A Conditional Principal Use, subject to approval as such.
 - (iv) A Conditional Accessory Use, subject to approval as such.
 - (v) A Temporary Use.

2.2 MULTIPLE USES OR PROVISIONS

- a) Where land, a building, or a structure is used for more than one purpose, all provisions of this By-law relating to each use must be satisfied.
- b) Where more than one provision in this By-law is applicable, the higher or more stringent requirement shall apply unless specified otherwise.

2.3 ACCESSORY USES AND STRUCTURES

No accessory use or structure shall be established, constructed, or erected, except those in compliance with the following regulations:

- a) No accessory use or structure shall be established prior to the establishment of the principal use of land, building or structure to which it is secondary.
- b) The area of land or buildings used or occupied for accessory uses on a site shall not exceed the area of land or buildings respectively used or occupied by principal uses on the same site.
- c) No land, building, or structure shall be used or occupied for any accessory use after the use or uses to which it is accessory have been discontinued.
- d) Where the accessory building or structure is attached to a principal building or structure, it shall be subject to, and shall conform to, all regulations of this By-law applicable to the principal building or structure.
- e) Where the accessory building or structure is detached from the principal building or structure, it shall be subject to, and shall conform to, all regulations of this By-law applicable to accessory buildings or structures.
- f) No accessory building or structure shall be constructed on any site prior to the time of construction of the principal building to which it is accessory except where it is allowed by written agreement from the Municipality.
- g) An accessory building or structure shall not be used as a dwelling, except where otherwise permitted in this By-law.

2.4 TEMPORARY BUILDINGS, STRUCTURES, OR USES

Temporary buildings, structures, or uses listed in Section 3.4 may be allowed on a non-permanent basis subject to the issuance of a development permit under the following conditions:

- a) Each development permit issued for a temporary building, structure or use shall be valid for a period of not more than 12 months and may not be renewed for more than two successive periods at the same location, unless approved so by the Designated Officer.
- b) The temporary use or structure must not be detrimental to property or improvements in the surrounding area or to the public health, safety, or general welfare.
- c) The temporary use or structure must not have adverse impacts on nearby residential neighbourhoods.
- d) The temporary use or structure must not result in permanent alterations to the site.
- e) Tents and other temporary structures must be located so as not to interfere with the normal operations of any permanent use located on the property.
- f) A temporary use is not permitted unless sufficient off-street parking is adequate to accommodate anticipated parking needs associated with the temporary use.

2.5 NUMBER OF BUILDINGS PERMITTED PER SITE

There shall be only one principal building on a site except wherein otherwise stated.

2.6 SEPARATION OF PRINCIPAL BUILDING AND ANY OTHER BUILDING

The minimum distance between the principal building and any other building shall be 6 ft (2 m), unless otherwise provided for herein.

2.7 SERVICE CONNECTIONS

Where a parcel is served by municipal piped sewer or water, no permanent principal building or dwelling shall be constructed or placed unless it is connected to such services.

2.8 NOXIOUS OR OFFENSIVE USES

- a) Notwithstanding anything herein contained, no use shall be permitted in any zone which may be noxious or offensive by reason of the emission or production of odour, dust, refuse matter, wastes, vapour, smoke, gas, vibration, or noise.
- b) If the use is permitted in the subject zone, satisfactory measures shall be undertaken to mitigate or eliminate such effects and necessary licensing shall be obtained from the Province of Manitoba, as required.

2.9 STORAGE OF AUTOMOBILES, PARTS OR MACHINERY

- a) There shall be no storage of derelict automobiles, parts or any other machinery in any required front, side or rear yard unless approved by Council.

2.10 PROJECTIONS IN REQUIRED YARDS

- a) Required yards shall be free of buildings, except accessory buildings which must conform to the other requirements of this By-law.
- b) Wheelchair ramps (or similar accessibility structures) are not subject to the restrictions for required yards.
- c) Open, unenclosed stairs and landings may extend into the required yards for not more than 50% of the required yard depth, up to a maximum of 5 ft (1.5 m), whichever is lesser.
- d) Unenclosed decks, patios, and balconies 2 ft (0.6 m) or less in height (as measured from the underside of the joists to the ground) may extend into the required yards for not more than 50% of the required yard depth, up to a maximum of 5 ft (1.5 m), whichever is lesser.
- e) Enclosed decks, patios and balconies with sunroom or screen enclosures shall have the dimensional standards of the principal building apply when attached to the principal building and the dimensional standards of detached accessory structures apply when detached from the principal building.
- f) Enclosed projections of a building, including chimneys, alcoves, and bay windows may extend into a required yard up to 50% of the required yard depth to a maximum projection of 5 ft (1.5 m), whichever is the lesser, provided that no more than 10 sq ft (0.9 sq m) of area within any required yard is occupied by these types of projection.
- g) Landscaping features such as driveways, sidewalks, and patios at grade level, ornamental plantings, fences, and other decorative features are permitted within any required yard.
- h) Fences are permitted in all required yards and can be placed up to the property line.

2.11 HEIGHT EXCEPTION

The provisions of this By-law shall not apply to limit the height of any ornamental dome, chimney, electrical or telephone transmission lines and towers, steeple, public utility structures, electrical apparatus, or agricultural structures such as silos, grain elevators, terminals, feed mills, seed plants.

2.12 FENCES

- a) Fence height is measured from the highest part of the fence to the point where the fence post enters grade. Where a fence is located on top of a retaining wall, the height to the fence shall include the height of the retaining wall measured from the finished grade.

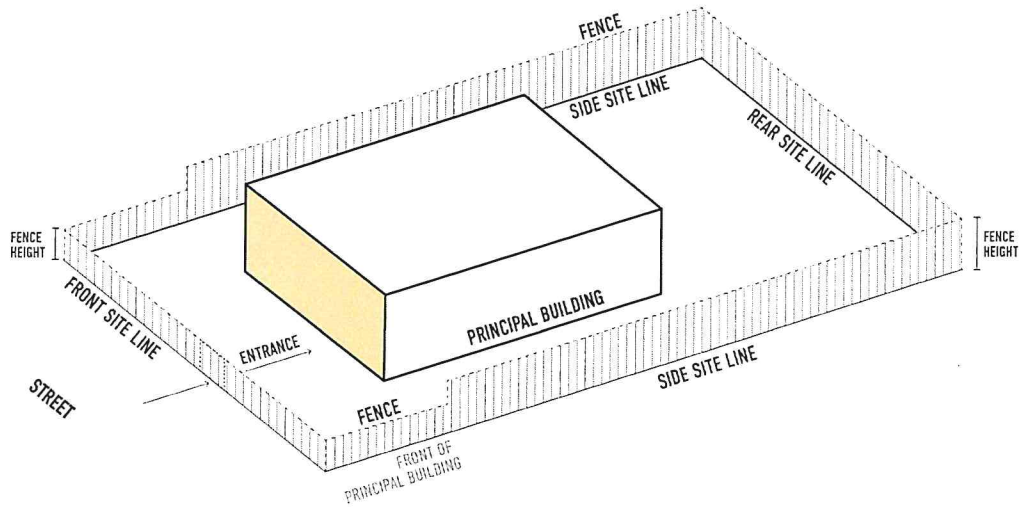

- b) Fences shall:
- (i) Not be electrified, except as an accessory to a permitted industrial, institutional, or agricultural use in the **AG** zone.
 - (ii) Not contain barbed wire, except as an accessory to a permitted industrial or agricultural use in the **AG** zone.
 - (iii) Not contain scrap metal, wood palettes, or industrial waste material.
- c) No fence shall exceed the following heights:

LOCATION	RR	SR	AG	GD
Front Yard (Max.)	4 ft (1.2 m)	4 ft (1.2 m)	4 ft (1.2 m)	4 ft (1.2 m)
Side and Rear Yards (Max.)	7 ft (2.1 m)	7 ft (2.1 m)	10 ft (3.0 m)	7 ft (2.1 m)

Table 1. Standard Fence Heights

2.13 ROADS AND HIGHWAYS

- a) No permanent building may be constructed or placed on a parcel which does not have legal access to a public road, without the approval of Council and entering into an agreement.
- b) No buildings or structures shall be erected upon any undeveloped road allowance. Any development adjacent to said road allowance shall comply with the requirements of this By-law as to yard requirements.
- c) All development within the Controlled Area of a provincial road or provincial trunk highway shall require a permit from the applicable provincial authority.

2.14 RAILWAYS

- a) Nothing in this By-law shall be so interpreted as to interfere with the normal operations and maintenance of the railways.
- b) Any railway office buildings, warehouse facilities, maintenance buildings and storage areas shall be subject to the provisions of this By-law.
- c) No residential development shall be permitted within 100 ft (30 m) of a railway main line, or within 50 ft (15 m) of a branch line or spur line, measured from the property line of the railway to the face of the residential building.
- d) The required side or rear yard shall be zero feet for those structures which require railway service for loading or unloading.

2.15 PUBLIC AIRCRAFT LANDING AREAS

- a) Any proposal to establish any building or structure which exceeds a building height of 10 ft (3m), or to establish a shelterbelt or similar obstruction within the flight approaches of any public aircraft landing area for one (1) mile (1.6 km) shall be subject to Council approval.

2.16 PARKING

- a) An accessory parking area must comply with the minimum yard requirements for the zone in which the parking area is located.
- b) Off-street parking spaces shall meet the parking stall and aisle specifications in Table 2. If the proposed spaces are designed at an angle that is not in Table 2, use the specifications for the angle that is closest.

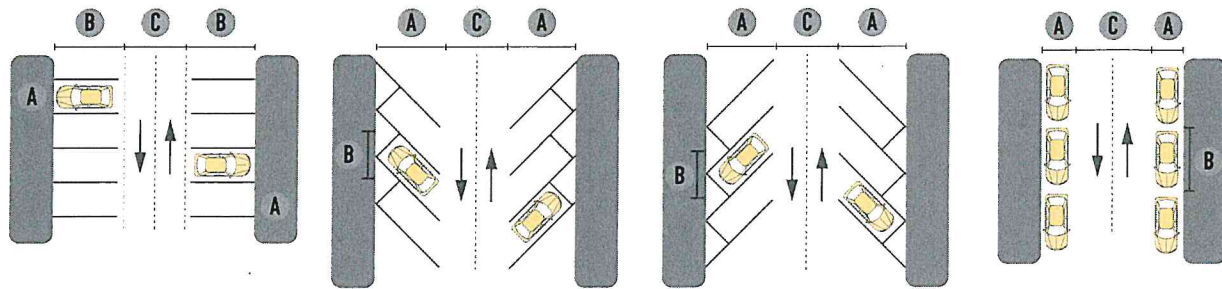

ANGLE OF PARKING (DEGREES)	WIDTH OF STALL (FT)	WIDTH OF AISLE (FT)	DEPTH PERPENDICULAR TO AISLE (FT)	WIDTH PARALLEL TO AISLE (FT)
a	b	c	d	e
30	9	12	15	17
45	9	12	18	12
60	9	20	20	10
90	9	24	20	9

Table 2. Minimum Parking Requirements

Minimum Spaces

- a) Accessory off-street parking spaces shall be provided according to the minimum number of spaces as calculated by Table 3 for uses indicated in Table 3.
- b) All accessory off-street parking spaces shall be located on the same site as the principal use, unless specifically permitted to locate elsewhere. There are no parking requirements for uses/zones not included in the table.

USE / USE CLASS	MINIMUM SPACES	UNIT
Bed and Breakfasts, Hotels and Similar Uses	1.5	Per individual suite or bedroom
Dwellings, Multi-Unit	1.5	Per dwelling unit
All Other Residential Uses and Dwelling Types	1.0	Per dwelling unit
All Other Uses in the GD zone	1.0	Per 1,500 sq ft (139.4 sq m) of floor area ^b
a) A fraction of 0.5 or more of a parking space shall be counted as 1 parking space.		
b) Gross floor area excluding any area used for parking within the principal building and any area used for incidental service storage, mechanical equipment, or similar uses		

Table 3. Minimum Accessory Off-Street Parking Spaces

Off-Street Loading

- c) At least one (1) loading space shall be provided for each non-residential building in the **GD** zone.
- d) The loading space shall be a minimum width of 12 ft (3.7 m) and a minimum length of 50 ft (15.2 m).

Barrier-Free Spaces

- a) Barrier-Free parking spaces for non-residential uses shall be provided according to the minimum number of spaces specified by Table 4.
- b) Each Barrier-Free parking space shall have a minimum width of 11.5 ft (3.5 m) and a minimum length of 23 ft (7 m).
- c) Barrier-Free parking spaces shall be located within close proximity and access to the principal building entrance.
- d) Barrier-Free spaces must be clearly marked and reserved for the exclusive use of people with accessible parking permits.

NUMBER OF OFF-STREET PARKING SPACES ON A ZONING SITE	MINIMUM NUMBER OF BARRIER-FREE PARKING SPACES
1 – 25	1
26 – 50	2
51 – 75	3
76 – 100	4
101+	4 plus 1 for every 50 additional spaces, to a maximum of 10 spaces

Table 4. Barrier Free Parking Space Minimums

2.17 SIGNS

General Regulations

- a) All signs shall comply with the minimum yard requirements for accessory structures in the zone in which they are to be located or erected.
- b) No sign or sign structure shall be erected at any location where it may interfere with or obstruct the view of any street, intersection, or railroad grade crossing, or be confused with any authorized traffic sign, signal, or device.
- c) No rotating beam, beacon or flashing illumination resembling an emergency light shall be used in connection with any sign display.
- d) No sign or sign structure shall be erected or maintained on, over or above any land or right-of-way belonging to the Municipality without approval from the Municipality and a Development Permit.
- e) The placing of signs within the controlled area of a Provincial Road or Provincial Trunk Highway shall require a permit from the applicable provincial authority.
- f) All signs and sign structures shall be kept in good repair and in a proper state of preservation. Signs which have become obsolete because of discontinuance of the operation or activity or are not maintained in good condition or repair shall be repaired, removed, or relocated by the property owner within 30 days following notice by the Designated Officer.

Permitted Signs

- a) Billboards and other signs directing attention to a business, commodity or message offered elsewhere than upon the same zoning lot on which that sign is located may only be allowed in zones where Advertising Sign is a Permitted or Conditional use.
- b) The following signs shall be permitted and do not require a development permit. However, they must still comply with any applicable standards in this By-law:
 - (i) One identification sign per permitted or approved use (except Dwelling, Single-unit and Dwelling, Two-unit) to a maximum not exceeding 32 sq ft (3 sq m) in surface area.
 - (ii) Signs posted by duly constituted public authorities in the performance of their public duties.
 - (iii) Flags or emblems of a political, civic, educational, or religious organization.
 - (iv) Commemorative or memorial signs or tablets.
 - (v) Temporary signs including real estate signs, construction signs, election signs, garage sale signs and similar.
 - (vi) Mobile (temporary) signs on the same site as the event or business, not exceeding 35 sq ft (3.3 sq m) in surface area (for a single sign face), for a maximum of 30 days, which may be extended by Council for an additional 30-day period.
 - (vii) Awning signs with signage originally incorporated in the design or awning material.
 - (viii) Residential on-site identification signs or warning signs (such as "Private Property" signs and similar) not exceeding 4 sq ft (0.4 sq m) each in surface area.
 - (ix) Directional signs for parking and loading.
 - (x) Real Estate and temporary construction signs not exceeding 172 sq ft (16 sq m) in surface area (for a single sign face).
 - (xi) Signs required for direction and convenience of the public, including signs identifying restrooms or parking entrances, not exceeding 5 sq ft (0.5 sq m) in sign surface area.

2.18 SUBDIVISIONS

- a) No parcel of land shall hereafter be divided into sites, unless each site conforms to the regulations set forth in the Dimensional Standards Table for the zone in which said parcel is located.
- b) Approval of a subdivision is subject to the provisions contained in *The Planning Act* and the policies contained within the *Lakeshore Planning District Development Plan* and amendments thereto.
- c) Notwithstanding that a parcel of land may exceed the minimum site area and site width requirements, Council is not, in any manner, obligated to approve a subdivision.

2.19 SITE AREAS AND YARDS

All yards and other open spaces required for any use shall be located on the same site as the use.

Double Frontage Sites

- a) Where a site has frontage along two more or less parallel streets, the following provisions shall apply:
 - (i) Where the site depth is greater than 200 ft (61 m), both site lines which abut these streets shall be considered to be front site lines, and the adjacent yards shall both be considered to be required front yards.
 - (ii) Where the site depth is 200 ft (61 m) or less, only one site line shall be considered to be the front site line, and this determination shall be made by the Designated Officer, based on the arrangement of existing buildings in the immediate area.

Unconventional Sites

- a) Where a site is of such unique configuration that the required yards cannot be ascertained, the Designated Officer may designate the location of the required yards.
- b) The location and required dimensions of such yards shall be consistent with the intent of the yards specified for the zone within which the site is located.

Flag Lots

- a) Where flag lots have been created prior to the effective date of this By-law, the following standards apply:
 - (i) The minimum width of the strip of land used to provide driveway access to the buildable portion of the flag lot shall be 20 ft (6.1 m).
 - (ii) Within the access strip, the owner must erect and maintain a property address sign meeting the other standards in this By-law.
 - (iii) The lands adjacent to the intersection of the access driveway and the right-of-way of the public street or lane must comply with the other standards in this By-law.
- b) The creation of new flag lots is prohibited unless:
 - (i) The lands proposed for flag lot access are located in the **RR, AG, and GD** zones.
 - (ii) The lands proposed for flag lot development are located more than 150 ft (45.7 m) from the nearest existing or planned public street or lane.
 - (iii) A Designated Officer determines that there is no feasible alternative way to provide access to such lands.

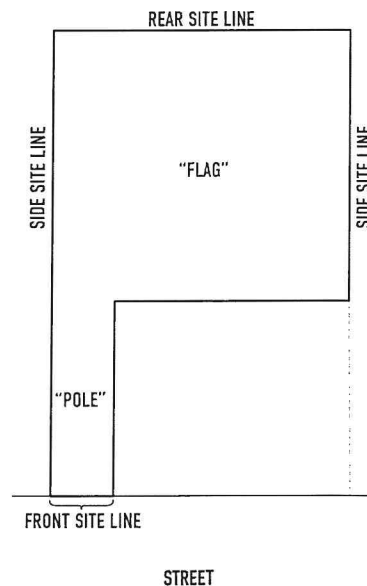

Party Walls

- a) A building divided into units of residential, commercial, or industrial uses may be subdivided along vertical party walls to permit the sale of individual units.
- b) The applicable side yard requirements shall be considered fulfilled for those side site lines contained within the party walls.

Site Reduced

- a) Where a use is established on a site and a site area, site width, or required yard is reduced below the minimum requirements of this By-law by virtue of the development of a public work, street or public utility, the affected site area, site width, and required yard shall be deemed to conform to the requirements of this By-law.
- b) Where new buildings or structures are proposed, the required yards shall be determined by the location of actual site boundaries.

Infilling

- a) Where sites comprising 40% or more of the entire frontage of the block are developed with buildings, the average front yard depths established by such buildings shall establish the minimum front yard depths for the entire frontage of the block provided such average is less than the minimum front yard required in the zone in which the site is located.

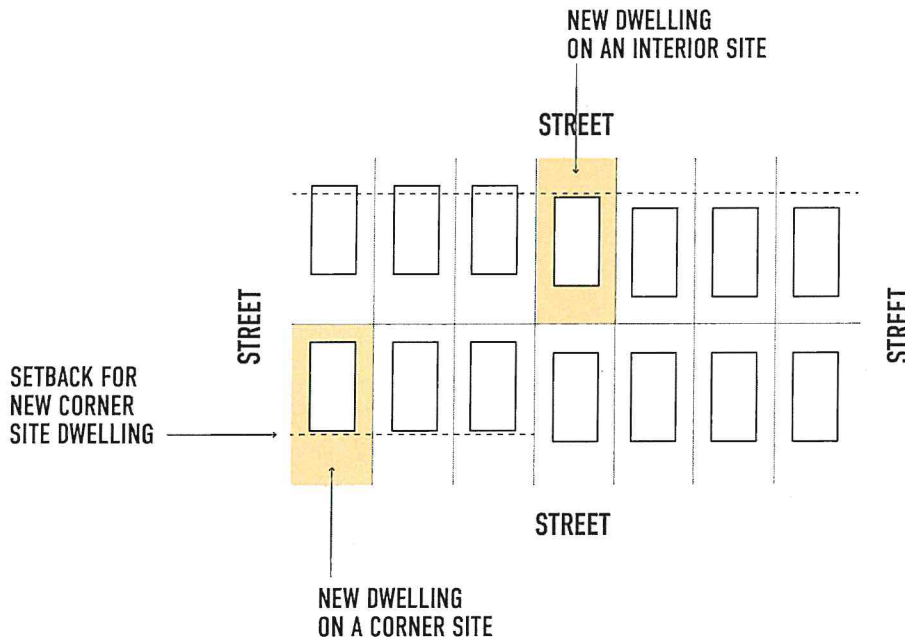

2.20 CORNER VISION TRIANGLES

- a) Corner vision triangles shall be maintained at the street corners of all sites located adjacent to street intersections within the **RR** and **GD** zones.
- b) The corner vision triangle shall be a triangular area measured 10 ft (3 m) from the street corner of the site along each site line adjacent to the street.

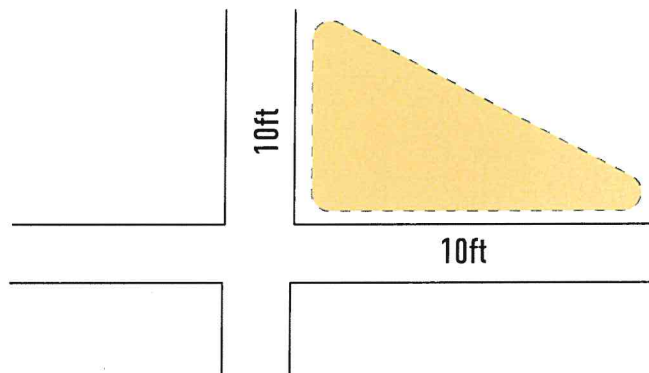

- c) No wall, fence, hedge, shrub, or other landscaping feature which would substantially diminish the visibility of motorists shall be allowed to exceed a height of 3 ft (0.9 m) within these corner vision triangles.

2.21 HAZARD LANDS

Development is prohibited on land that is subject to subsidence or erosion by water or is marshy, unstable, or is otherwise hazardous by virtue of its soil or topography, unless a geotechnical engineering report showing that the development may occur without creating any additional risks is submitted to the Municipality at the time of application for a development permit.

2.22 BUILDING GRADE AND FLOODING

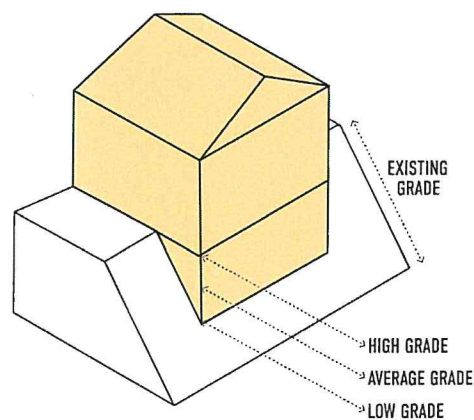

- a) Development is prohibited on land that is within 2 ft (0.6 m) of the high-water mark of the design flood, a recorded flood exceeding the design flood, or a flood specified by Manitoba Transportation and Infrastructure, unless an engineering report showing the development, with

flood protection, may occur without creating any additional risks is submitted to the Municipality at the time of application for a development permit.

- b) The landowner shall establish and maintain lot grading for adequate drainage so that there will be no free flow of water onto public sidewalks or adjacent properties other than through a drain, ditch, or swale.
- c) No person shall proceed with any work that may alter or otherwise change the grading of a lot or property in any manner that may affect the existing or established storm water runoff from that or any adjacent property without first obtaining a development permit.

2.23 RIPARIAN AND WETLAND AREAS

- a) No development shall occur within the area 100 ft (30 m) upslope from the normal high-water mark of a natural water body, waterway, wetland, or a third (or higher) order drain, except if the development is permitted as an exception below.
- b) No development shall occur within 50 ft (15 m) of a first or second order drain, or artificially created retention pond, except if the development is permitted as an exception below.

Exceptions to Riparian Setbacks

- a) Developments that create minor disturbances to the natural vegetative cover of riparian areas (such as docks, boathouses, and pathways) may be allowed within the riparian and wetland area, provided no more than 25% of the length of a lot's shoreline is affected.

Protection of Important Areas

- a) No development shall occur 100 ft (30 m) upslope from the normal high-water mark of a water body or waterway identified in the Development Plan as being socially, historically, or culturally important, being designated under an enactment, or containing unique aquatic assemblages and species.
- b) The natural vegetative cover must be retained or rehabilitated within these areas.

No Alteration of Wetlands

- a) Development shall not result in alteration to permanent, semi-permanent or coastal wetlands by the consolidation of wetlands or by ditching, filling, pumping, subsurface drainage, or other works or means, unless it is for the purpose of flood mitigation.
- b) Flood mitigation must maintain the natural boundaries of permanent, semi-permanent, or coastal wetlands.

2.24 MONUMENTS AND STATUARIES

Nothing in this By-law shall be so interpreted as to interfere with the maintenance or erection of monuments, statuary, and similar structures, provided that any building or structure erected in any zone complies with the yard and area requirements applicable to the zone.

2.25 BUILDING REMOVAL

Upon completion of removal, relocation, or demolition of a building from a site, the old foundation shall be removed, any excavation shall be filled, the ground shall be leveled, and the site shall be put in a safe condition to the satisfaction of the Designated Officer unless special approval is granted by Council.

PART 3: ZONES

3.1 ESTABLISHING ZONES

Uses of land in the Municipality are regulated in accordance with the following zones:

ZONE		INTENT
Residential Rural	RR	Areas that are low density, non-farm residential on lots by plan of subdivision utilizing on site sewer and water services.
Seasonal Recreational	SR	Areas for seasonal developments utilizing recreational land adjacent to rivers, lakes, etc. including year-round purposes.
Agricultural General	AG	Areas for general agricultural activities, other small holdings, and non-farm development compatible with farming operations on large parcels of land.
General Development	GD	Areas for a mixture of residential, commercial, industrial, and recreational uses.

Table 5. Municipal Zones

3.2 PERMITTED AND CONDITIONAL USES

The uses prescribed for parcels within each zone are those set out in the Use Table as follows:

Permitted Use	P
Conditional Use	C
Permitted only as an Accessory Use	<u>P</u>
Conditional only as an Accessory Use	<u>C</u>
Use Specific Standard applies	U.S.S.
If blank, the use is not permitted	

USE	RR	SR	AG	GD	U.S.S.
Abattoirs			C		
Advertising Signs (>300 sq ft)	C	C	C	C	
Advertising Signs (<300 sq ft)	P	P	P	P	
Agri-Business			C	C	
Agriculture, Cropping	P		P	P	
Agriculture, General	P		P	C	
Agriculture, Specialized			P	C	
Airfields			C		
Amusement Enterprise, Indoor				C	

USE	RR	SR	AG	GD	U.S.S.
Amusement Enterprise, Outdoor				P	
Anhydrous Ammonia Storage Facility			C	C	4.1
Apiary			P		4.2
Auction Mart			C		
Auction Mart (non-livestock)				C	
Automotive and Recreation Vehicle Sales and Service				C	
Bed and Breakfast		C		P	4.3
Boarding or Rooming House (5 or more suites)	C			C	
Boarding or Rooming House (less than 5 suites)	P			P	
Boat Docks and Boat Houses, Private		P			
Boat Docks and Boat Houses, Public		C			
Body Modification Services				P	
Brewery				C	
Camping and Tenting Grounds		P		P	4.4
Cannabis Cultivation			C		
Cannabis Sales				C	4.1 4.5
Cemetery			C	C	
Child Care Facility	C			P	
Child Care, Home	<u>P</u>			<u>P</u>	
Clubs, Private or Public		C	C	P	
Commercial Services				P	
Commercial Storage			C	C	
Community Garden	P	P	P	P	4.6
Community/Recreation Centre or Facility			C	P	
Cryptocurrency Processing Facility			C		
Drive-in Theatre			C		
Dwelling, Cottage		P			4.8
Dwelling, Multi-Unit				P	4.9
Dwelling, Single-Unit	P	P		P	4.9
Dwelling, Single-Unit, Farm			P		
Dwelling, Single-Unit, Non-Farm			C		
Dwelling, Two-Unit	C			P	4.9
Earth-Moving Contractors			C		
Emergency Service	P	P	P	P	
Food and/or Drink Establishment		C		P	
Forestry Use			C		
Fuels, Bulk Sales and Storage				C	

USE	RR	SR	AG	GD	U.S.S.
Funeral Chapel, Mortuary, or Crematorium				C	
Gallery/Museum or Historic Site			C	P	
Garden Centres/Nurseries			P	P	
Golf Course		P	C		
Group Camp		C	C		
Junk Yard/Scrap Yard			C		
Hazardous Bulk Storage and Sales			C		4.1
Home Industry	<u>C</u>	C	<u>C</u>	<u>C</u>	4.11
Home-Based Business	<u>P</u>	P	<u>P</u>	<u>P</u>	4.10
Hospital / Clinic, Dental, Medical, or Optical Related Facility				P	
Hotel or Motel		C		P	
Industrial, Heavy			C	C	
Industrial, Light				C	
Kennel	C		C	P	4.1
Library/Cultural Facility				P	
Liquor Distillery				C	
Liquor Sales		C		P	
Livestock Operation (up to 199 AU)			P		4.12
Livestock Operation (200+ AU)			C		4.12
Mining and Extraction			C		4.1 4.13
Mobile / Manufactured Home	C		P	C	4.14
Mobile / Manufactured Home Park	C	C		C	4.15
Non-hazardous Bulk Storage and Sales, Exterior				C	
Non-hazardous Bulk Storage and Sales, Interior				P	
Office				P	
Outfitting Cabins / Lodges		C	C		
Park/Plaza/Square/Playground	P	P	P	P	
Parking, Surface Lot				P	
Personal Services, unless otherwise listed				P	
Place of Worship	P	P		P	
Public Utility	C	C	C	C	
Public Works Facility	P	P	P	P	
Recycling Depot				C	
Rehabilitation/Healing Centre				C	
Residential Care Facility/Assisted Living Facility, 5 persons or more	C			P	
Residential Care Facility/Assisted Living Facility, up to 4 persons	P			P	
Retail, Large		C		C	

USE	RR	SR	AG	GD	U.S.S.
Retail, Small				P	
Schools, Private or Public				P	
Secondary Suite	P	P	P	P	4.17
Service Station		C		P	
Sewage Treatment Plants and Lagoons			C	C	4.1
Shipping Containers	P		P	P	4.19
Sleep Cabin		P			
Solar Collector	C	C	C	C	4.20
Stable			P		
Telecommunication Towers	C	C	C	C	
Theatre				P	
Trades and Contracting Facilities	C	C	C	C	
Trucking Establishments			C	C	
Veterinary Clinic			C	C	
Waste Disposal Grounds/Sites			C		4.1
Water Treatment Plants and Reservoirs		C	C		4.1
Wholesale Businesses and Warehousing				C	
Wildlife and Heritage Conservation Areas / Nature Reserves		P	P		
Wind Energy Generating System, Commercial	C	C	C	C	4.22
Wind Energy Generating System, On-site / Rooftop	C	C	C	C	4.23

3.3 ACCESSORY BUILDINGS AND STRUCTURES

The following Accessory Buildings or Structures are permitted in all zones:

ACCESSORY BUILDING OR STRUCTURE	U.S.S.
Accessory off-street parking and loading areas	2.16
Antennas	
Deck, patio, ramp, and gazebo	
Detached private garage, carport	4.7
Portable garage	4.16
Private garden house, play structure, greenhouse, or conservatory	
Private swimming pool (open or enclosed) or pond	4.21
Production, processing, cleaning, servicing, repair, or storage of merchandise normally incidental to commercial occupancies if conducted by the owners of the principal use and contained within a building	
Refuse and garbage disposal areas	
Signs	2.17
Storage of goods used in or produced by manufacturing, agricultural or resource-related activities or office/administration on the same site as a principal use	

Structures related to agricultural or resource activities	
Tool house, shed, or other similar building	

3.4 TEMPORARY USES, BUILDINGS AND STRUCTURES

The following Temporary Uses, Buildings or Structures are permitted in all zones subject to the requirements below and in Section 2.4:

TEMPORARY USES, BUILDING OR STRUCTURE
Portable Asphalt and Concrete Batch Plant
Canvas Buildings and Tents
Construction Trailer or Building
Emergency Residential Shelter
Farmers' Market
Fundraising Event
Seasonal Sales
Outdoor Special Event

- a) Travel Trailers or Recreational Vehicles shall not be stored or occupied within residential subdivisions prior to the occupation of the main dwelling, except where it is allowed under a written agreement with the municipality.
- b) One Recreational Vehicle belonging to an owner or occupier or guest/visitor of the owner or occupier of the principal single detached dwelling may be located on the same parcel containing the principal dwelling. Such recreational vehicle shall only be used for temporary accommodation.
- c) Temporary construction trailers or buildings must be removed from the premises within one month after completion of construction.
- d) Seasonal uses must not reduce the number of required off-street parking or loading spaces below the minimums required by this By-law, obstruct any vehicular circulation route into or through the property.

3.5 DIMENSIONAL STANDARDS

No land, building, or structure shall be used or occupied, and no building or structure shall be constructed, erected, altered, enlarged, or placed, except in accordance with the dimensional standards described in the Dimensional Standards Table or elsewhere in this By-law.

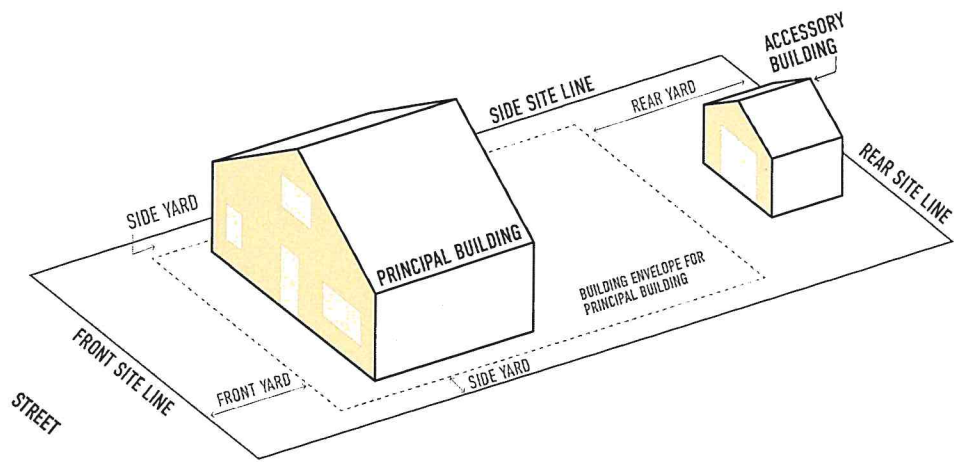

ZONE	USE	SITE				YARD				FORM	
		AREA (MIN.)	WIDTH (MIN.)	COVERAGE (MAX)	FRONT (MIN.)	SIDE INTERIOR (MIN.)	REAR (MIN.)	HEIGHT (MAX.)			
RR	All RR Uses	2 ac (0.8 ha)	300 ft (91.4 m)	60%	125 ft (38.1 m)	25 ft (7.6 m)	25 ft (7.6 m)	2 storey	(30 ft)		
	Accessory Buildings / Structures ^b	-	-	-	25 ft (7.6 m)	5 ft (1.5 m)	6 ft (1.8 m)	1 storey	(15 ft)		
SR	Dwelling, Cottage	9,000 sq ft (836 sq m)	75 ft (23 m)	60%	25 ft (7.6 m)	10 ft (3 m)	25 ft (7.6 m)	2 storey	(30 ft)		
	Camping and Tenting Grounds	30,000 sq ft (2,787 sq m)	100 ft (30.5m)	-	25 ft (7.6 m)	10 ft (3 m)	25 ft (7.6 m)	1 storey	(15 ft)		
	All Other SR Uses	15,000 sq ft (1,393.5 sq m)	100 ft (30.5m)	70%	25 ft (7.6 m)	15 ft (4.6 m)	25 ft (7.6 m)	2 storey	(30 ft)		
	Accessory Buildings / Structures ^b	-	-	-	25 ft (7.6 m)	5 ft (1.5 m)	6 ft (1.8 m)	1 storey	(15 ft)		
AG	Agricultural / Livestock	80 ac ^a (32.4 ha)	1,000 ft (304.8 m)	-	125 ft (38.1 m)	25 ft ^b (7.6 m)	25 ft ^b (7.6 m)	-	-		
	All Other AG Uses	2 ac (0.8 ha)	200 ft (61 m)	-	125 ft (38.1 m)	25 ft ^b (7.6 m)	25 ft ^b (7.6 m)	-	-		
	Accessory Buildings / Structures	-	-	-	125 ft (38.1 m)	25 ft ^b (7.6 m)	25 ft ^b (7.6 m)	-	-		
	Agricultural	20 ac (8.1 ha)	400 ft (122 m)	-	125 ft (38.1 m)	25 ft (7.6 m)	25 ft (7.6 m)	2 storey	(30 ft)		
GD	All GD Uses (Serviced)	5,000 sq ft (464.5 sq m)	40 ft (12 m)	70%	25 ft (7.6 m)	5 ft (1.5 m)	25 ft (7.6 m)	2 storey	(30 ft)		
	All GD Uses (Unserviced)	13,500 sq ft (1,254.2 sq m)	100 ft (30.5m)	70%	25 ft (7.6 m)	15 ft (4.6 m)	25 ft (7.6 m)	2 storey	(30 ft)		
	Accessory Buildings / Structures	-	-	-	25 ft (7.6 m)	25 ft (7.6 m)	25 ft (7.6 m)	2 storey	(30 ft)		
ALL	Parks/Plaza/Squares/Playgrounds	1,000 sq ft (93 sq m)	50 ft (15.2 m)	-	25 ft (7.6 m)	5 ft (1.5 m)	15 ft (4.6 m)	2 storey	(30 ft)		

- a) 80 acres (32.4 ha) shall include land taken for a highway road allowance, drainage ditch or right-of-way and excepted from the certificate of title or consists of two legal subdivisions which abut each other, and the resulting parcel abuts on a highway or is being consolidated with an adjoining parcel of land which abuts on a highway.
- b) Where a side or rear yard is adjacent to a municipal road, that yard shall be 125 ft (38.1 m).

3.6 SPECIAL DIMENSIONAL STANDARDS

The following dimensional standards shall apply to the areas described below.

LOCATION	SITE			YARD			FORM	
	AREA (MIN.)	WIDTH (MIN.)	COVERAGE (MAX)	FRONT (MIN.)	SIDE INTERIOR (MIN.)	REAR (MIN.)	HEIGHT (MAX.)	
Plan Nos. 195, 198, 734, 1133, 1334, 25291, 28901, 29446, 35743, 36148 and 37867 Dauphin Land Titles Office	5,000 sq ft (464.5 sq m)	50 ft (15.2 m)	70%	25 ft (7.6 m)	5 ft (1.5 m)	25 ft (7.6 m)	2 storey	(30 ft)

PART 4: USE-SPECIFIC STANDARDS

Regardless of whether a use is allowed as a permitted or a conditional use, and regardless of the zoning district in which the use is located, the following standards for specific uses must be met, except as otherwise provided in this By-law or by a conditional use or variance order:

4.1 MUTUAL SEPARATION DISTANCES

The following mutual separation distances shall be established:

	Uses	Mutual Separation Distance
Airport	Any Building or Structure	500 ft (152 m)
	Dwelling	1,000 ft (305 m)
Anhydrous Ammonia Storage Facility	Dwelling	2,640 ft (800 m)
	Any Industrial building	450 ft (137 m)
	Right-of-Way, Municipal Road, Provincial Road or Highway	328 ft (100 m)
	School, Hospital, Recreation Facility, Institutional Residence	2,640 ft (800 m)
Animal Keeping	Dwelling	250 ft (76 m) ^a
Cannabis Sales	School, Another Cannabis Sales Store	1,000 ft (305 m)
Hazardous Bulk Storage and Sales	Dwelling	500 ft (152 m)
Inland Grain Terminal	Dwelling	500 ft (152 m)
Kennel	Dwelling	2,640 ft (805 m) ^b
Livestock Operations	See Subsection 4.12	
Mining and Extraction	Dwelling	500 ft (152 m)
Sewage Treatment Site or Lagoon	Dwelling	1,500 ft (457 m)
Waste Disposal Site	Dwelling	1,320 ft (400 m) ^c
Water Treatment Facility or Reservoir	Dwelling	500 ft (152 m)
a) Other than the owner of the animals b) Unless confined within a building or structure c) Unless for an abandoned site it can be demonstrated by licensed engineer that methane gas generation will not create a problem in the building to be erected.		

4.2 APIARY (BEEKEEPING)

Apiaries shall be subject to the following regulations:

- a) Shall be considered as a conditional use when proposed to be located within 1 mile (1.6 km) of an **RR, SR, and GD** zones.
- b) Every landowner who allows the keeping of bees on their property has the duty to ensure the maintenance of the beehives. The bees must be requeened if they swarm or show signs of aggressive behaviour.

4.3 BED AND BREAKFAST

Bed and Breakfasts shall be subject to the following regulations:

- a) The operator must reside within the principal residence to which the Bed and Breakfast is an accessory use.
- b) No more than 8 patrons shall be accommodated within one Dwelling.
- c) No more than 5 bedrooms shall be used for the bed and breakfast operation.
- d) One additional on-site parking spot shall be provided for each bedroom that is used for the bed and breakfast operation.
- e) Signs shall follow the regulations for home-based businesses.

4.4 CAMPING AND TENTING GROUNDS

Camping and Tenting Grounds shall be subject to the following regulations:

- a) More than one camp space or recreational vehicle may be permitted on a site.
- b) Must provide a roadway with an all-weather surface that serves all dwellings with a driving surface a minimum of 13 ft (4 m) wide.
- c) Must provide storage of refuse in a sanitary manner at a location not more than 500 ft (150 m) from any dwelling.
- d) Must provide clear numbered identification of each camping space.
- e) Must provide a centrally located recreation area equivalent to a minimum area of 215 sq ft (20 sq m) per camping space.
- f) Must provide one (1) guest parking spot per camping space.

4.5 CANNABIS SALES

Cannabis Sales Stores shall be subject to the following regulations:

- a) A cannabis sales store must comply with all Federal and Provincial regulations.

4.6 COMMUNITY GARDEN

Community Gardens shall be subject to the following regulations:

- a) Community gardens shall not be larger than 25,000 sq ft (2,320 sq m), except in the **AG** zone.
- b) Accessory buildings for community gardens must meet the accessory dimensional standards for the zone in which they are located.

4.7 DETACHED GARAGE

- a) Where an accessory building is used for the storage of a vehicle, the wall containing the vehicular access door shall be set back a minimum of 10 ft (3 m) from a public lane or street.
- b) For a corner side yard, the wall containing the vehicular access door shall be set back a minimum of 20 ft (6.1 m) from a public lane or street.

4.8 DWELLING, COTTAGE

Cottage Dwellings shall be subject to the following regulations:

- a) The minimum dwelling unit area for a Cottage Dwelling in the **SR** zone shall be 480 sq ft (44.6 sq m)
- b) In the SR zone, recreational vehicles, travel trailers or other moveable equipment used for an accommodation shall not occupy or be parked in lieu of a Cottage.

4.9 DWELLING

Dwellings shall be subject to the following regulations:

- a) The minimum Dwelling unit area in all zones shall be 600 sq ft (55.7 sq m)
- b) Single-Unit Dwellings are conditional as a secondary use above the first storey of the building or in the rear portion of the main floor of a principal commercial use in the **GD** zone.
- c) Two-Unit and Multi-Unit Dwellings shall have no required side yard on a side that shares a party wall with a building on an adjacent site.

Subdivision of Attached Dwellings

A site with a Two-unit Attached Dwelling or Row-type Dwelling may be subdivided into two or more sites provided that:

- a) Any new site line shall, where possible, be a straight line between the front and rear site lines, located in such a manner that the party wall of two adjacent units shall form part of the new site line.
- b) Each site created shall have frontage on a street, public lane or other means of legal access as may be approved by Council.
- c) Each site created shall provide not less than one (1) on-site parking space having access directly to either a street public lane or other legal access.
- d) The permitted use for each site created shall be for one (1) attached Single-unit Dwelling only.
- e) All applicable Building By-law provisions shall be complied with.
- f) Any new site created shall have a minimum site area of 3,500 sq ft (325.2 sq m) and a minimum site width of 35 ft (10.7 m).
- g) No side yard is required along the party wall.

4.10 HOME INDUSTRY

Home Industry shall be subject to the following regulations:

- a) Shall be conducted by a resident or residents of the dwelling unit to which the Home Industry is secondary, and may employ a maximum of:
 - (i) 10 non-resident persons in the **AG** zone.
 - (ii) 5 non-resident persons in the **GD** zone.
 - (iii) 2 non-resident persons in all other zones.

- b) Not have processing or outside storage of goods in all zones, except for the **AG** zone. The location of all exterior processing and storage shall be subject to Council approval in the **AG** zone.
- c) Not have more than 40% of the total floor area of buildings on the site devoted to the business in all zones, except for the following:
 - (i) Not more than 600 sq ft (55.7 sq m) of all floor area in the **RR** and **GD** zones.
 - (ii) No floor restrictions shall apply in the **AG** zone.
- d) Have a maximum of one business sign, either freestanding or affixed to the wall of a principal or accessory building, not exceeding:
 - (i) 32 sq ft (3 sq m) in the **AG** zone.
 - (ii) 10 sq ft (0.9 sq m) in all other zones where home-based businesses are allowed.
- e) Must not produce any offensive noise, vibration, traffic, smoke, dust, odour, glare, heat, or electrical interference as determined by the Designated Officer.

4.11 HOME-BASED BUSINESS

Home-Based Businesses shall be subject to the following regulations:

- a) In the **RR** and **GD** zones, exterior storage of products or materials must be limited to the Rear Yard. The storage shall not project above the height of a fence or screening.
- b) In the **RR** and **GD** zones, the area used to carry out the Home Industry shall not occupy more than 1,076 sq ft (100 sq m).
- c) Shall be conducted by a resident or residents of the dwelling unit to which the Home-Based Business is secondary and may employ a maximum of 2 non-resident persons.
- d) Have a maximum of one business sign, either freestanding or affixed to the wall of a principal or accessory building, not exceeding:
 - (i) 32 sq ft (3 sq m) in the **AG** zone.
 - (ii) 10 sq ft (0.9 sq m) in all other zones where home-based businesses are allowed.
- e) The proponent of the Home-Based Business must obtain a development permit before establishing or expanding a Home-Based Business on a site.
- f) In the case of rental premises, the proponent will be required to obtain the permission of the owner of the premises before a development permit will be issued.

4.12 LIVESTOCK OPERATIONS

Livestock Operations shall be subject to the following regulations:

- a) Operations meet the separation distances as stipulated in the development plan and based on the animal unit (AU) calculations and criteria outlined in Table 6 and Table 7.
- b) Livestock operations requiring conditional use approval may be subject to the following conditions, if imposed by council:
 - (i) Measures to ensure conformity with the Development Plan, Secondary Plan and By-law.

- (ii) Either or both of the following measures to reduce odours from the operation:
 - Covering manure storage facilities.
 - The establishment of shelterbelts.
 - (iii) Enter into a development agreement regarding one or more of the following:
 - The timing of construction.
 - The control of traffic.
 - The construction and maintenance of roads, fencing, landscaping, drainage works, or shelterbelts.
 - The payment of a sum of money to the board or council to be used by the board or council to construct any of the items mentioned above.
- c) An application for approval of a livestock operation involving 200 or more animal units (cumulative across species) shall:
- (i) Be sent to the minister for referral to the Technical Review Committee for review.
 - (ii) Be subject to the measures to implement the recommendations of the Technical Review Committee.

ANIMAL	TYPE	ANIMAL UNITS PRODUCED BY ONE ANIMAL	NUMBER OF ANIMALS TO PRODUCE ONE AU
Dairy	Milking Cows, including associated livestock	2	0.5
Beef	Beef Cows, including associated livestock	1.25	0.8
	Backgrounder	0.5	2
	Summer pasture / replacement heifers	0.625	1.6
	Feeder Cattle	0.769	1.3
Hogs	Sows, farrow to finish	1.25	0.8
	Sows, farrow to weanling	0.25	4
	Sows, farrow to nursery	0.313	3.2
	Weanlings	0.033	30
	Growers / finishers	0.143	7
	Boars (artificial insemination operations)	0.2	5
Chickens	Broilers	0.005	200
	Roasters	0.01	100
	Layers	0.0083	120
	Pullets	0.0033	300
	Broiler Breeder Pullets	0.0033	300
	Broiler Breeder Hens	0.01	100
Turkeys	Broilers	0.01	100
	Heavy Toms	0.02	50
	Heavy Hens	0.01	100
Horses	Mares, including associated livestock	1.333	0.75
Sheep	Ewes, including associated livestock	0.2	5
	Feeder Lambs	0.063	16

Table 6. Animal Units by Category of Livestock

Source: Appendix 1, Provincial Planning Regulation 81/2011 THE PLANNING ACT (C.C.S.M. c. P80)

Specialty Animals by Category of Livestock

ANIMAL	TYPE	ANIMAL UNITS PRODUCED BY ONE ANIMAL	NUMBER OF ANIMALS TO PRODUCE ONE AU
Alpacas, llamas		0.17	6
Bison	Cows and associated livestock	1.25	0.8
Ducks	Growing for Meat	0.017	58
	Mature	0.024	42
Emu		0.06	16
Geese	Growing for meat	0.024	42
	Mature	0.045	22
Goats	Miniature	0.22	4.5
	Mature	0.14	7
	Plus associated livestock	0.2	5
Horses	Large	1	1
	Small to Medium	0.667	1.5
	Miniature	0.222	4.5
Mink		0.005	219
Ostrich		0.14	7
Ponies	All	0.4	2.5
Rabbits	Does (includes associated bucks and litters)	0.1	10

SIZE OF LIVESTOCK OPERATIONS IN ANIMAL UNITS (A.U.)	SEPARATION DISTANCE IN FEET (METRES) FROM SINGLE RESIDENCE		SEPARATION DISTANCE IN FEET (METRES) FROM DESIGNATED AREAS	
	TO EARTHEN MANURE STORAGE FACILITY OR FEEDLOT	TO ANIMAL CONFINEMENT FACILITY OR NON-EARTHEN MANURE STORAGE FACILITY	TO EARTHEN MANURE STORAGE FACILITY OR FEEDLOT	TO ANIMAL CONFINEMENT FACILITY OR NON-EARTHEN MANURE STORAGE FACILITY
10 - 100	656 (200)	328 (100)	2,625 (800)	1,739 (530)
101 - 200	984 (300)	492 (150)	3,937 (1,200)	2,625 (800)
201 - 300	1,312 (400)	656 (200)	5,249 (1,600)	3,511 (1,070)
301 - 400	1,476 (450)	738 (225)	5,906 (1,800)	3,937 (1,200)
401 - 800	1,640 (500)	820 (250)	6,561 (2,000)	4,364 (1,330)
801 – 1,600	1,968 (600)	984 (300)	7,874 (2400)	5,249 (1,600)
1,601 – 3,200	2,297 (700)	1,148 (350)	9,186 (2800)	6,135 (1,870)
3,201 – 6,400	2,625 (800)	1,312 (400)	10,499 (3,200)	6,988 (2,130)
6,401 - 12,800	2,953 (900)	1,476 (450)	11,811 (3,600)	7,874 (2,400)
>12,800	3,281 (1,000)	1,640 (500)	13,123 (4,000)	8,760 (2,670)
<ul style="list-style-type: none"> • Mutual separation distances to single residences will be measured to the building itself. • Separation distances to designated areas will be measured to the boundaries of the designated areas found in the development plan, not the buildings within. 				

Table 7. Minimum Separation Distances for Siting Livestock Operations

- a) The designated areas for the separation distances in Table 7 shall be Rorketon Settled Area, Ochre River Settled Area Settled Area, Rural Residential Area Policy Area, General Development Policy Area and Recreation Policy Area as identified in *the Lakeshore Planning District Development Plan*, Rainbow Beach and Dauphin Lake.
- b) All lawfully established, existing livestock operations within the areas identified above, at the date of adoption of this by-law, shall be deemed to be Conditional uses and expansion of existing livestock operation will require a Conditional Use process.
- c) Notwithstanding the above criteria, livestock production operations within 2 miles (3.2 km) of designated areas will be subject to the policies of *the Lakeshore Planning District Development Plan*.
- d) No manure storage facility shall be constructed or located without first obtaining the required permit from the Province and must adhere to provincial setbacks.
- e) No new livestock operations are permitted within 2638 ft (804m) of Ochre River, Rorketon, and designated Recreation Areas. Existing operations can expand up to 100 AU within 2638 ft (804m) as a conditional use, and existing operations within 2638 to 5279ft (804 to 1609m) of those areas can expand up to 300 AU as a conditional use.

4.13 MINING AND EXTRACTION

Mining and Extraction shall be subject to the following regulations:

- a) Before a development permit is issued, an applicant must provide the Municipality with the following:
 - (i) In the case of Crown quarry minerals, proof of the issuance of a Provincial Lease or Casual Permit under Provincial Regulations, registration for a private quarry (if applicable) or proof of insurance of a mineral lease or mining claim in non-quarry mineral extraction also requires a municipal development permit.
 - (ii) A plan showing areas and means for goods and waste transportation.
 - (iii) A site plan showing the operation, the manner in which extraction or development will occur, the means of visual buffering and noise and dust protection.
 - (iv) A plan for the rehabilitation and intended use(s) of the site upon completion of the operation phase, subject to provincial regulations.
- b) No building or structure shall be constructed or located within an area (a buffer of 492 ft (150 m)) which has been designated as a high or medium quality aggregate area by the Province, unless the site has been further reviewed by the Province and a recommendation provided which would allow development to proceed.

4.14 MOBILE/MANUFACTURED HOMES

Mobile/Manufactured Homes shall be subject to the following regulations:

- a) All mobile/manufactured homes, even those constructed outside the Municipality, must meet the structural standards in *The Buildings and Mobile Homes Act*.
- b) A mobile/manufactured home, when located permanently on a site, shall:
 - (i) Be placed and anchored on a permanent foundation in accordance with *CSA Z240.10.1 Site Preparation, Foundation, and Anchorage for Manufactured Homes* standard.
 - (ii) Have skirting that screens the view of the foundation supports or wheels.

4.15 MOBILE/MANUFACTURED HOME PARK

Mobile/Manufactured Home Parks shall be subject to the following regulations:

- a) Shall contain a minimum of 10 mobile/manufactured home spaces.
- b) Shall meet the structural standards in *The Buildings and Mobile Homes Act*, even those constructed outside the Municipality.
- c) Mobile/Manufactured homes when located permanently on a site, shall:
 - i) Be placed and anchored on a permanent foundation.
 - ii) Have skirting that screens the view of the foundation supports or wheels.
- d) Provide a roadway with a driving surface a minimum of 16.5 ft (5 m) wide with an all-weather surface that serves all dwellings that meets the municipal roadway lighting and surface water drainage standards.
- e) Provide clear identification of each dwelling space and its boundaries.
- f) An application for a Mobile/Manufactured Home Park must be accompanied with a detailed site plan, including:

- i) Location of the site boundaries.
- ii) Foundations, pads, or mobile home sites.
- iii) Accessory buildings.
- iv) Internal roads.
- v) Sidewalks and active transportation paths.
- vi) Vehicle parking.
- vii) Systems supplying electrical power, water, and sewage disposal.

4.16 PORTABLE GARAGES

Portable Garages shall be subject to the following regulations:

- a) Not allowed within the required front yard of a site.
- b) Shall meet the requirements for accessory building side and rear yard requirements.
- c) Shall not exceed the height restrictions for accessory buildings in the zone in which it is located.
- d) Shall be kept in good condition. Any rip in the fabric must be repaired.

4.17 SECONDARY SUITES

Secondary Suites shall be subject to the following regulations:

- a) Not more than one attached or detached Secondary Suite shall be permitted on a single parcel.
- b) A minimum of one off-street parking space must be provided for each Secondary Suite, in addition to the parking required for the principal building.
- c) The maximum floor area of the Secondary Suite shall not exceed 860 sq ft (80 sq m) or 40% of the total habitable floor space of the principal building (whichever is the lesser).
- d) Detached Secondary Suites must follow the setback standards for accessory buildings and structures.

4.18 SERVICE STATIONS

Service Stations shall comply with the following regulations:

- a) All pump islands and underground storage tanks shall be located a minimum of 20 ft (6.1 m) from any boundary of the site, parking area on the site, or laneways intended to control traffic circulation on the site, not including canopies situated above said pumping islands.
- b) Pump islands or fuelling stations are not permitted in a required parking area.
- c) A minimum of 5 in-bound and 3 out-bound stacking spaces shall be provided for each service bay.
- d) All stacking spaces shall be a minimum of 18 ft (5.5 m) long and 10 ft (3 m) wide.
- e) All stacking spaces shall be located so as not to block or interfere with the smooth flow of traffic to and from required off-street parking spaces or the driving aisles providing access to those spaces, or any adjacent street or lane through an approved access point.

4.19 SHIPPING CONTAINER

Shipping containers shall be subject to the following regulations:

- a) A shipping container used for storage must meet the requirements for accessory buildings in the zone in which it is located.
- b) Shipping containers, when stacked, must not exceed the maximum height for accessory buildings for the zone.
- c) A shipping container used as a dwelling must meet the requirements for dwelling units in the zone in which it is located (as well as the requirements necessary to receive a building permit).
- d) A shipping container may be used for temporary storage or emergency purposes, provided it meets the requirements for temporary buildings and structures in this By-law.
- e) A shipping container may be used for purposes other than those described above (e.g., commercial uses) if it meets the other requirements for that use in this By-law as well as the requirements necessary to receive a building permit.
- f) A shipping container shall be kept in good condition, be a consistent neutral colour, and relatively free of rust.

4.20 SOLAR COLLECTOR

Solar collectors shall be subject to the following regulations:

- a) Any solar collector not connected to a building shall adhere to the same setbacks and height restrictions for accessory buildings in the zone in which the installation is situated.
- b) A roof or wall-mounted solar collector shall not exceed, in size, the total square footage of the principal structure.
- c) A solar collector that is mounted on a roof may project a maximum of 6.5 ft (1.5 m) from the surface of the roof and must not extend beyond the outermost edge of the roof.
- d) A solar collector that is mounted on a wall may project a maximum of 2 ft (0.6 m) from the surface of that wall and must be located a minimum of 8 ft (2.4 m) above grade.

4.21 SWIMMING POOLS AND HOT TUBS

Permanent Swimming Pools, Hot Tubs and similar structures capable of holding water to a depth of greater than 2ft (0.6m) shall be subject to the following regulations:

- a) Shall be allowed as a permitted accessory use to a residential use, recreational or commercial development.
- b) Must meet the siting requirements of accessory structures for the zone in which they are located.
- c) The pool area shall be protected by a fence with lockable gates and a minimum height of 6 ft (1.8 m) to prevent unauthorized entry. The fence and gate must be constructed to prevent a child from climbing over or crawling underneath and maintained in good repair.
- d) Hot tubs shall have a walkable cover.
- e) Shall comply with the requirements under *The Public Health Act*.

4.22 WIND ENERGY GENERATING SYSTEM TOWER (COMMERCIAL)

A Commercial Wind Energy Generating System Tower shall be subject to the following regulations:

- a) Shall be set back no less than 1.5 times the total turbine height from the property line and any public road or railway right of way
- b) Shall be set back no less than 100 ft (30m) from a water body or waterway
- c) The minimum separation distance between a commercial wind energy generating system tower and the nearest habitable building shall be 1,640 ft (500 m)
- d) Shall contain no commercial advertising other than the manufacturer's or owner's name or logo
- e) Shall contain no artificial lighting other than the lighting that is required by federal and provincial regulation
- f) As part of their development permit application, proponents for Wind Generation System must submit a detailed site plan showing the location of all wind generating devices, associated accessory buildings or structures, electrical lines (above or below ground) on-site roads and driveways providing access to the public road system

4.23 WIND ENERGY GENERATING SYSTEMS (ON-SITE / ROOFTOP)

An On-site / Rooftop Wind Energy Generating System shall be subject to the following regulations:

- a) Shall be set back at least 20 ft (6 m) from the front building line, or, in the case of corner lots, at least 15 ft (4.5 m) from the front and side lot line.
- b) Shall be limited to a total turbine height of no more than 15 ft (4.5 m) above the rooftop.
- c) Shall be safely and securely attached to the rooftop in compliance with the National and Provincial Building Codes.

PART 5: ADMINISTRATION

5.1 ADMINISTRATION AND ENFORCEMENT

In the administration and enforcement of this By-law, the Municipality shall have all of the powers of inspection, remedy and enforcement provided under Part 12 of *The Planning Act*.

5.2 THE DEVELOPMENT OFFICER

- a) The Building Inspector of the MLA Planning Region is hereby established as the Development Officer of the Municipality.
- b) The person appointed as Development Officer by council shall be a *Designated Officer* for the purposes of *The Planning Act*.
- c) Additional Designated Officers have decision making authority as outlined in this By-law.

5.3 ROLES OF THE DESIGNATED OFFICER

The Designated Officer shall have the authority to:

- a) Issue development permits and exercise the powers of administration, inspection, remedy, and enforcement provided in Part 12 of *The Planning Act*.
- b) Refuse to issue a development permit where:
 - (i) The development permit application, or any information accompanying the development permit application, is incorrect or incomplete.
 - (ii) The proposed building, structure or use does not, to the Designated Officer's knowledge, comply with this By-law, the Building By-law or with any other law.
- c) Revoke a development permit where the development permit was issued in error.
- d) Make a minor variance order, without the need for a public hearing, for any proposed change that varies:
 - (i) Any height, distance, area, size, or intensity of use requirement in this By-law by no more than 15%.
 - (ii) The number of parking spaces required by this By-law by no more than 15%.

5.4 DEVELOPMENT PERMITS

When Development Permits are Required

A development permit is required for any of the following, except as otherwise provided for in this By-law:

- a) The erection, construction, demolition, enlargement, structural alteration or placing of a building or structure, either permanent or temporary.
- b) The establishment of a use of land or a building or structure.
- c) The change of a use of land or a building or structure from the existing use to a use which is not a permitted use.
- d) The alteration or enlargement of an approved conditional use.

Development Permits and Other Permits

The issuance of a development permit in respect of building or structure does not affect the obligation to obtain a building permit or other permit where required under the building by-law, or another law, by-law, or regulation, for such a building or structure.

When Development Permits are Not Required

- a) A development permit is not required for the following:
 - (i) Incidental alterations, except when a building permit is required.
 - (ii) Agricultural cropping of land.
 - (iii) The erection, construction, enlargement, structural alteration or placing of the following as accessory structures:
 - Fences, below 4 ft (1.2 m) in height.
 - Signs, not including advertising signs where they are conditional uses.
 - Outdoor lighting.
 - Flagpoles.
 - Sheds and buildings with a floor area of less than 150 sq ft (13.9 sq m).
 - Garden houses or children's playhouses.
 - Private sewage disposal systems.
 - Private communications facilities.
 - Unenclosed patios at grade level.
- b) Despite not requiring a development permit, all items in this provision shall be subject to requirements of this By-law.

Applications for Development Permits

An application for a development permit:

- a) Shall be made by the owner or owners of the parcel in question, or by a person authorized in writing by them.
- b) Shall be accompanied by plans drawn to scale showing the following:
 - (i) The shape and dimensions of the parcel to be used or built on.
 - (ii) The location and dimensions of existing buildings and structures and their distances from property lines.
 - (iii) The location and dimensions of any proposed building, structure, enlargement, or alteration.
 - (iv) The use or uses of each existing and proposed building and structure, or of the land, and the area to be occupied by each use.
 - (v) Vehicular access, utility connections.
 - (vi) Any other information required by the Designated Officer to determine compliance with, and to provide enforcement of, this By-law.

- c) Shall be accompanied by the fee prescribed by the Municipality.

5.5 VARIANCES

Purpose of a Variance

This By-law applies general zoning regulations to the entire Municipality. However, there may be locations where the standards in a zone impose an unreasonable limitation on the development or use of a site due to its particular characteristics, including parcels of land that are odd-shaped or have other physical characteristics that make complying with the requirements of this By-law impractical or unreasonable.

Minor Variances

This By-Law outlines the process for minor variances, without the need for a public hearing, for proposed changes that vary the standards in this By-Law by no more than 15%.

Applying for a Variation Order

Any person who believes that this By-law adversely affects their property rights may apply for an order varying specific provisions of this By-law insofar as they apply to the affected property, in accordance with *The Planning Act*.

General Requirements

- a) A building, structure or use established by a variance order prior to the effective date of this By-law shall, subject to the provisions of the variance order, be deemed to conform to this By-law.
- b) A variance order shall expire or cease to have any effect if it is not acted upon within 12 months from the date it was made, unless it is renewed before the expiration date at the discretion of Council for an additional period not exceeding 12 months.

5.6 CONDITIONAL USE

Purpose of Conditional Uses

This By-law is based upon the division of the Municipality into zones where the use of the land, buildings and structures are compatible. There are, however, certain uses designated Conditional Uses, which cannot properly be permitted without consideration, in each case, of the impact of those uses upon neighboring land.

Applying for a Conditional Use

Any owner may apply for a Conditional Use in accordance with this By-Law and with the provisions of *The Planning Act*.

General Requirements

- a) Approval of a conditional use shall expire or cease to have any effect if it is not acted upon within 12 months from the date it was made, unless it is renewed before the expiry date at the discretion of Council for an additional period not exceeding 12 months.
- b) A use that is listed as a conditional use within this By-law, but that lawfully existed prior to the effective date of this By-law, shall be considered a lawfully existing conditional use.

- c) Changes to an existing conditional use, such as enlargement, expansion, or extension to occupy a greater floor area or site area upon which said use is located, shall require conditional use approval except for changes to farm buildings that house livestock as per *The Planning Act*.
- d) In the case of aggregate extraction operations, existing pits may be expanded within the site, provided that no new pits are established and provided that said operation was a legally existing conditional use at the effective date of this By-law. The aggregate extraction operation shall otherwise conform to the requirements of the zone in which it is located.

5.7 ZONING MEMORANDA

- a) A zoning memorandum may be issued upon application of any person having an interest in land, land use, a building or structure within the area affected by this By-law, stating whether or not the land, building, structure, and use appears to conform with this By-law, in accordance with *The Planning Act*.
- b) A request for a zoning memorandum must be accompanied by a Building Location Certificate prepared by a Manitoba Land Surveyor.

5.8 APPLICATIONS

- a) An application for a variance, conditional use, or an amendment to this By-law must be in the proper form and must be accompanied by the fee prescribed by Council.
- b) The application must also be accompanied by:
 - (i) Plans drawn to scale showing the shape and dimensions of the affected property.
 - (ii) Plans drawn to scale showing the location and dimensions of existing buildings and structures.
 - (iii) Plans drawn to scale showing the location and dimensions of the proposed building, structure, enlargement, or alteration.
 - (iv) A description of the use or uses of each existing and proposed building or structure, or of the land and the area to be occupied by each use.
 - (v) A description of the reason why the variance, conditional use, or amendment to this By-law is being requested.
 - (vi) Any other information required by the Designated Officer to determine compliance with, and to provide for enforcement of, this By-law.

Fee Schedule

- c) The fees shall be as established by Council for any amendment, conditional use, variance, zoning memorandum or non-conforming use certification to this By-law.
- d) Council shall by by-law establish a fee schedule for development permits and other charges to be paid by any person for services rendered by any employee of the Municipality.

5.9 DEVELOPMENT AGREEMENT

Where an application is made for an amendment to this By-law, Council may require the owner or the person entitled to be registered as owner of the land, building or structure to which the amendment shall

apply, as a condition to its enactment to enter into a development agreement with the Municipality in respect to that land as well as contiguous land owned or leased by the applicant.

5.10 NON-CONFORMITY

- a) If a building, a parcel of land, the use of land, or intensity of a use of land was lawfully existing before the adoption of this By-law and now does not conform to the regulations in this By-law, it is considered a lawfully existing non-conformity.
- b) Under *The Planning Act*, lawfully existing non-conformities are considered legal and can continue indefinitely, provided the use is not intensified or changed to another non-conforming use.
- c) All uses of land, buildings, or structures that lawfully existed prior to the effective date of this By-law, where the use was not discontinued for a period exceeding 12 consecutive months, may continue.
- d) A non-conforming site or parcel may be occupied by any building, structure, or use provided:
 - (i) The building, structure or use is listed as a permitted or conditional use within the zone in which said site or parcel is located.
 - (ii) All other requirements of the zone in which the site or parcel is located are complied with or variance orders have been issued.
- e) If a landowner wants to increase the intensity of an existing non-conforming use or make repairs or additions on a non-conforming building, the landowner may apply for a variance.
- f) An owner of a parcel of land that does not conform to a new zoning by-law may continue to use the land for any use approved under the previous zoning by-law and construct or alter a building on the land as long as all other requirements (including height and required yards) are met.
- g) Additional regulations for lawfully existing non-conformities are found in *The Planning Act*.
- h) The legal status of buildings, structures or land, or their use, is not affected by change of ownership, tenancy or occupancy of the building, structure, or land.
- i) A certificate may be issued by Council upon application of any person having an interest therein, describing the land, building, or structure, or the use or intensity of use of land or a structure that was lawfully in existence at the date of the enactment of this By-law, and stating it may continue to exist although it does not conform to this By-law, in accordance with *The Planning Act*. A request for a certificate of non-conformity for a building or structure must be accompanied by a Building Location Certificate prepared by a Manitoba Land Surveyor.

PART 6: DEFINITIONS

6.1 DEFINITIONS IN THE PLANNING ACT

Terms not defined in this By-law which are defined in *The Planning Act* have the meaning provided in that act.

6.2 DEFINITIONS IN THIS BY-LAW

Where the following terms appear in this By-law, they have the meaning provided as follows:

A

Abattoirs means a building, structure, or part thereof, used for the slaughtering of animals and related activities.

Accessory means a use, building or structure that is naturally and normally incidental, subordinate in purpose or area, or both, and exclusively devoted to the use, building, or structure to which it is accessory. A use shown as a conditional use in the Use Table cannot be accessory to a use shown as a permitted use for the same zone.

Advertising Sign means a sign directing attention to a business, commodity, service, entertainment, or other matter, not conducted, sold, offered, or carried out on the same site (or on an adjacent site under the same ownership) where the sign is maintained.

Agri-Business means an establishment that provides goods or services to the agricultural sector, including (but not limited to) farm equipment and machinery repair shops, feed operations, and commercial seed cleaning plants.

Agricultural, General means a use of land for agricultural purposes. Typical uses include farming, agriculture, aquaculture, floriculture, and horticulture. This does not include Livestock Operations.

Agricultural, Specialized means an agricultural operation in which high value, lower volume, intensively managed agricultural products are produced on a smaller land holding than the minimum size required for general agriculture.

Aircraft Landing Area includes all open spaces, buildings and structures used in connection with the landing or take-off of aircraft.

Airport means land which is used or intended for the landing or take-off of aircraft and any associated areas which are used or intended for use for airport buildings or other airport facilities or rights-of-way, including taxiways, aircraft storage and tie-down areas, hangers, helipads, and other related buildings and open spaces.

Alterations, Incidental means changes or replacements in the non-structural parts of a building or structure, including, but not limited to the following:

- a) An addition, alteration, removal, reconstruction, or replacement on the non-structural exterior of a residential building.
- b) An addition, alteration, removal, reconstruction or replacement of any unroofed driveway, sidewalk, patio, or any accessory building floor.
- c) Alteration of non-load bearing interior partitions in all types of buildings.
- d) Replacement of, or changes in, the capacity of utility pipes, ducts, or conduits.

- e) Replacement and placement of necessary roofing materials, awnings, eaves, overhangs, and related structures provided the area and height of the roof are not increased.
- f) The addition and replacement of interior structures such as furnaces, fuel tanks, water heaters, fireplaces, or wood stoves.
- g) Replacement of exterior building facades.

Alterations, Structural means any change, which prolongs the life of the supporting members of a building or structure, which includes, but is not limited to, bearing walls, columns, beams, or girders.

Amusement Enterprise, Indoor means a commercial establishment designed and equipped for assembly occupancy uses for the conduct of sports, exercise and/or leisure-time activities within a fully enclosed building.

Amusement Enterprise, Outdoor means an outdoor facility whose main purpose is to provide the general public with entertainment or recreation, with or without charge.

Anhydrous Ammonia Storage Facility means an area for the storage of anhydrous ammonia that is commonly used as a fertilizer, including sales and service.

Animal Keeping means a use where livestock or other animals (excluding pets) less than 10 animal units (cumulative across species) are sheltered, bred, raised, or sold.

Apiary means any place where bees are kept.

Auction Mart means a development specifically intended for the auctioning of livestock and/or goods and equipment, including temporary storage of such goods and equipment.

Automotive and Recreation Vehicle Sales and Service means the retail sale or rental of new or used automobiles, motorcycles, snowmobiles, tent trailers, utility trailers, boats, travel trailers, or similar light recreational vehicles or crafts, together with servicing and mechanical repair. This includes automobile dealerships, car rental agencies and motorcycle dealerships, transmission shops, muffler shops, tire shops, automotive glass shops, and upholstery shops, but does not include body repair and paint shops.

B

Bed and Breakfast means a home-based business operated within a principal dwelling that provides short-term temporary lodging (other than a hotel or motel) and may also provide breakfast to guests.

Boarding or Rooming House means a building, other than a hotel or motel, which provides living units with separate sleeping areas and some combination of shared bath or toilet facilities. The building may or may not provide meals to guests for compensation and may or may not have separate shared cooking facilities for residents. Care, treatment, or supervision must not be provided to any resident.

Boat Docks and Boat Houses means a building or part thereof, used by the occupants of the premises primarily for the parking or storage of private boats or other personal watercraft, but does not include living accommodations.

Body Modification Services means a commercial establishment that provides physical body adornment by body piercing or tattooing including scarification and the insertion of implants.

Brewery / Liquor Distillery means a facility that possesses the appropriate license(s) issued by the Province of Manitoba to allow it to produce onsite, sell, and distribute beer or other liquor or distilled spirits. All processes, functions and mechanical equipment directly associated with the production of beer, wine or other liquor must be contained inside a building. A tasting room established in accordance with all Province of Manitoba regulations and licensing requirements for the consumption of beer or other liquor may form

part of the craft brewery or distillery. Other associated commercial sales and service uses may be established in conjunction, such as restaurant, drinking establishment or small-scale retail sales for the sale of merchandise associated with the brewery or distillery.

Building has the meaning provided in *The Planning Act*, except that it does not include a well, pipeline, excavation, cut, fill, or transmission line.

Bulk Storage and Sales means a place for the storage or distribution of large quantities of raw materials or industrial-related goods in above-ground containers. This use does not include anhydrous ammonia facilities.

Bus Depot means an area utilized by commercial carriers for pick-up or drop-off of passengers, including loading and unloading areas, shelters, restrooms, concessions, benches, information offices, parking, ticket sales, landscaping, lighting, and other such facilities and appurtenances.

Bus Garages and Compounds means a facility where public transportation buses are stored, repaired, and maintained.

C

Camping and Tenting Grounds means a development of land which has been planned and improved for the seasonal short-term use of motor homes, tents, campers, and similar recreational vehicles and is not used as year-round storage, or accommodation for residential use.

Cannabis means cannabis as defined in the *Cannabis Act*.

Cannabis Cultivation growing of cannabis plants, industrial hemp plants (those containing 0.3% THC or more), and harvesting material from those plants, as well as associated activities.

Cannabis Sales means the premises specified in a retail cannabis licence where the retail sale of cannabis is authorized.

Cannabis Processing means the manufacturing, packaging, and labelling of cannabis products designed for sale to consumers, and the intra-industry sale of these products, including to provincially/territorially authorized distributors, as well as associated activities.

Caterer/Catering Establishment means a place where food is prepared in large quantities and is then delivered and consumed elsewhere but does not include a retail store or restaurant selling food directly to the public.

Cemetery means a development of a parcel of land, primarily a landscaped open space for the entombment of the deceased and may include, as accessory uses, the following: columbaria, crematoria, cineraria mausoleums, and mortuaries, when operated in conjunction with and within the boundaries of such cemetery.

Child Care Facility means the provision of childcare services in a provincially licensed facility but not inside a home.

Child Care, Home means the provision of childcare services for no more than 12 children, in a provincially licensed facility accessory to a private dwelling.

Club, Private or Public means a non-profit organization incorporated as such by the Government of Canada or the Government of Manitoba. Includes those facilities licensed/used for the meeting, social, or recreational activities of non-profit philanthropic, social service, athletic, business, or fraternal organizations, without on-site residences. When licensed for the sale of alcoholic beverages by the Government of Manitoba, such a club is considered a "drinking establishment."

Commercial Services means a use related to the provision of professional, management, administrative, consulting, and financial services, but does not include health services, nor the processing, storing, or selling of goods for any associated businesses. Typical uses include, but are not limited to: the offices of lawyers, accountants, engineers, and other professions; banks, credit unions, and similar financial institutions; and, clerical, secretarial, or administrative services.

Commercial Storage means a development, which includes a series of enclosed storage bays or lockers, and may include exterior storage sites for recreational vehicles, all of which are intended for rental or lease to the public.

Communications Facilities means outdoor equipment and structures required for the purposes of transmitting or receiving television, radio, microwave, radar, laser, or similar communications signals. These facilities may include, but are not limited to: antennae, aerials, receiving dishes, transmission beacons, masts, and towers.

Community Garden means an area managed by a non-profit organization, a community-based entity, or a public entity where members of the community may grow plants for beautification, education, recreation, community distribution or personal use.

Community/Recreation Centre or Facility means a development for recreational, social, or multiple purpose use with or without fixed seats. Primarily intended for local community purposes.

Controlled Area is defined in *The Transportation Infrastructure Act*.

Control Line is defined in *The Transportation Infrastructure Act*.

Cryptocurrency Processing Facility means the operation of specialized computer equipment for the purpose of mining one or more blockchain-based cryptocurrencies. Typical physical characteristics of cryptocurrency mining include specialized computer hardware for mining operations as well as equipment to cool the hardware and operating space. For the purposes of the associated regulations, cryptocurrency mining does not include the exchange of cryptocurrency or any other type of virtual currency nor does it encompass the use, creation, or maintenance of all types of peer-to-peer distributed ledgers.

D

Designated Area means an area designated for use as an urban centre, settlement centre, rural residential area, cottage area, park area or recreational area in the applicable development plan.

Design Flood means a flood magnitude on a water body that, on average, is expected to occur once during a one-hundred-year period.

Drive-Through Facility means a facility designed to provide goods or services to the persons in standing (as opposed to parked) motor vehicles, including but not limited to a drive-through restaurant or bank.

Dwelling means one or more rooms used or intended to be used as a single housekeeping unit with cooking, sleeping and sanitary facilities. This includes a ready-to-move or modular construction dwelling but does not include mobile/manufactured homes.

Dwelling, Cottage means a building, located on a single site, containing one dwelling that is intended to be used seasonally or on a part-time basis.

Dwelling, Multi-Unit means a building, located on a single site, containing three or more dwellings (for example, row houses, town houses, or apartment buildings).

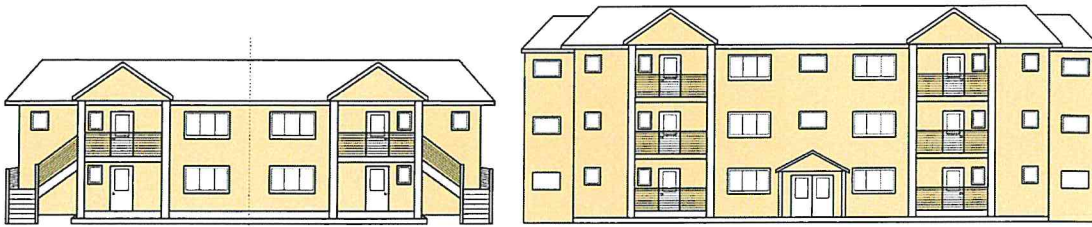

Dwelling, Single-Unit means a building, located on a single site, containing one dwelling.



Dwelling, Two-Unit means a building, located on a single site, containing two dwellings (for example, a duplex or a side-by-side).



E

Earth Moving Contractors facilities utilizing earth-moving equipment or heavy machinery that can move and grade soil and rock used for construction work, materials handling, demolition, mining, and any other industry that requires more power than can be provided by humans.

Emergency Residential Shelter means a facility where emergency temporary lodging is provided to persons who are homeless, due to indigence or disaster, operated by a public or non-profit agency, and where on-site supervision is provided whenever such shelter is occupied.

Emergency Service means a development which is required for the public protection of persons and property from injury, harm, or damage together with the incidental storage of emergency development which is necessary for the local distribution of utility services. Typical uses include police stations, fire stations, and ancillary training facilities.

F

Farmers' Market means an occasional or periodic market held in an open area or in a structure where groups of individual sellers offer for sale to the public such items as fresh produce, seasonal fruits, fresh flowers, arts and crafts items, and food and beverages dispensed from booths located on-site.

Food and/or Drink Establishment means a building or portion of a building, where the principal purpose is the sale to the public of prepared foods for consumption within the premises or off the site. This use class includes licensed drinking establishments.

Forestry Use means the general raising, harvesting, and cutting of wood, as well as forest renewal and maintenance activities. This use includes sawmills and related uses, including accessory structures.

Fuels/Bulk Sales, and Storage means an establishment or place operated at a fixed location for the storage of large quantities or public sales of gasoline or any other motor vehicle engine fuel.

Funeral Chapel, Mortuary, Columbarium, or Crematorium means a facility for storage and cremation, or a building used for the preparation of the deceased for burial and the display of the deceased and ceremonies connected therewith before burial or cremation.

Fundraising Event means an activity sponsored by a non-profit organization or public entity for the purpose of raising funds or providing information, other than a special event.

G

Gallery/Museum or Historic Site means a commercial establishment engaged in the sale, loan or display of paintings, sculpture, textiles, antiquities, or other works of art or a permanent facility, open to the public, with or without charge, for the collection and display of paintings, sculpture, textiles, antiquities, or other works of art. This type of use is distinct from and does not include libraries.

Garden Centres / Greenhouses / Nurseries means a development used primarily for the raising, storage, and sale of bedding, household, and ornamental plants.

General Agricultural Activities means an agricultural operation as defined in the Provincial Planning Regulation but does not include a livestock operation.

Golf Course means a public or private area operated for the purposes of playing golf and includes a club house and associated recreational facilities.

Grade means the average level of finished ground adjoining a building or structure at all exterior walls as determined by the Designated Officer.

Grain Terminal means a facility or area for the temporary storage of grain for transferal to trucks, train cars, or other forms of transportation.

Group Camp means a commercial recreational establishment that may consist of one or more buildings containing single or multi-unit dwellings, cabins, recreational facilities and service facilities that are used on an intermittent and seasonal basis. Other facilities that may be part of the resort development include: a campground, yurts, hotel, retail uses, eating and drinking establishment, marina, dock, boat ramps, golf course, and other outdoor recreational facilities, trails, and similar uses.

H

Hazardous Bulk Storage and Sales means a place for the storage or distribution of large quantities of hazardous or noxious goods such as farm chemicals, bulk fuel, or fertilizer, in above-ground containers.

Height means the total number of storeys in a building, or the vertical distance measured from grade to:

- a) The highest point of the roof surface of a flat roof.
- b) The deck or eaves of any other roof type.

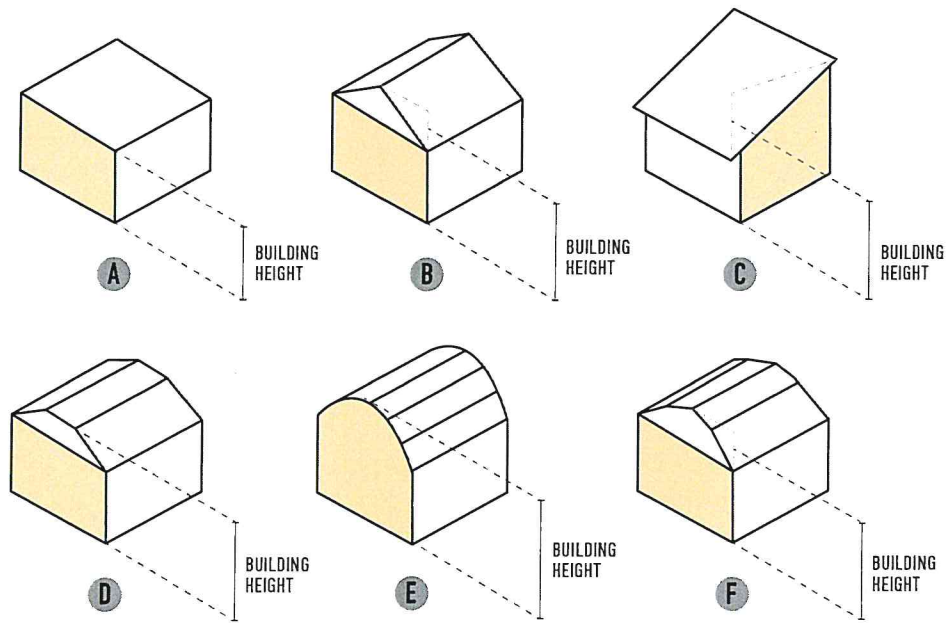

Home Industry means a light manufacturing operation that is carried out as a secondary use on the same site as a dwelling.

Home-Based Business means an occupation or activity operated entirely within or from a dwelling unit by a full-time resident that is accessory to the use of the premises as a dwelling.

Hospital / Clinic, Dental, Medical, or Optical Related Facility means an institution or facility that provides medical care or services including consultation, diagnosis, and treatment of patients by medical professionals. This may include administrative offices and staff, waiting rooms, laboratories, pharmacies / dispensaries, operating rooms on an out-patient basis and similar uses.

Hotel or Motel means a building or portion of a building providing temporary accommodation in individual guest rooms or suites for a fee, with or without provision for cooking in any individual guest room or suite.

I

Industrial, Heavy means a use of land that includes the assembly, fabrication, storage, or processing of goods and materials that may have impacts in terms of noise, fumes, odours, or safety hazards outside of the structures in which the use takes place.

Industrial, Light means a use of land that includes the assembly, fabrication, storage, or processing of goods and materials that do not create noise, fumes, odours, or safety hazards outside of the structures in which the use takes place.

J

Junk/Scrap Yard means a lot and/or premises for the storage and/or handling and/or sale of scrap, salvaged or used materials, and may include including a secondary sales and service establishment or premises.

K

Kennel means an establishment in which dogs or cats are housed, groomed, boarded, trained, bred, or sold, on a daily or overnight basis, for commercial purposes. A kennel shall not include a veterinary clinic, animal hospital, or animal pound.

L

Library / Cultural Facility means a development for the collection of literary, artistic, musical, and similar reference materials in the form of books, manuscripts, recordings and films for public use, or a development for the collection, preservation and public exhibition of works, or objects of historical, scientific or artistic value.

Livestock Operation means a permanent or semi-permanent facility or non-grazing area where at least 10 animal units of livestock are kept or raised either indoors or outdoors, and includes all associated manure collection facilities, but does not include an auction mart.

Liquor Sales means the commercial retail sales of beer, wine, liquor, and similar products.

M

Mining and Extraction means an area, pit or quarry from which aggregate, stone, minerals, including peat and soil, are removed / extracted.

Mobile/Manufactured Home means a portable dwelling unit that is designated to be used as living quarters that is capable of being transported on its own chassis and running gear by towing or other means.

Mobile/Manufactured Home Park means an area that is intended to be used, and is used, for the placing or parking of mobile/manufactured homes, and includes any auxiliary buildings or other structures or facilities intended for or to be used for cooking, personal cleanliness, washing, health or sanitation, or any one or more or all of those purposes and which has been approved by Council.

N**O**

Office means the use of a building or a portion of a building for the provision of services to a business, an organization, or to the public. It does not include the manufacturing of any product or the retail sales of goods.

Outfitting Cabins and Lodges means any land or premises equipped with cottage dwelling(s) used or maintained for accommodation of the public for outdoor recreation purposes related to hunting, fishing, nature pursuits, and like uses.

P

Park / Plaza / Square / Playground means a development of land specifically designed or reserved for the general public for active or passive recreational use and includes all natural and man made landscaping, facilities, playing fields, buildings and other structures that are consistent with the general purposes of public parkland, whether or not such recreational facilities are publicly operated or operated by other organizations pursuant to arrangements with the public authority owning the park. Typical uses include tot lots, band shells, picnic grounds, pedestrian trails and paths, landscaped buffers and playgrounds and water features.

Parking, Surface Lot means a space on the premises other than streets, used for the temporary parking of motor vehicles.

Party Wall means a wall forming part of a building and used for separation of adjoining buildings occupied, constructed, or adapted to be occupied by different persons or businesses.

Personal Services means a development used for the provision of personal services to an individual which are related to the care and appearance of the body, or the cleaning and repair of personal effects. This

includes barbershops, hairdressers, beauty salons, tailors, dressmakers, shoe repair shops, and dry-cleaning establishments and laundromats. This use does not include Body Modification Establishments.

Place of Worship means a building (ex: a church, chapel, mosque, synagogue, or temple) primarily used for religious purposes.

Portable Asphalt or Concrete Batch Plant means a temporary facility with equipment designed to heat, dry, and mix aggregate to produce paving material and includes stockpiling and storage of bulk materials used in the process.

Portable Garage means a temporary structure intended to store goods or materials that may consist of metal or steel frame and is covered by such material as canvas, plastic, polyethylene, various types of fabric or similar materials.

Principal Use means the primary or predominant activity on any lot or within any building or structure.

Principal Building means a structure on a site used to accommodate the principal use.

Public Utility means a system furnishing water, sewage collection, electricity, electrical charging, telecommunication services, gas, or similar services to properties by means of pipes, lines and other equipment located on or under public roads and other rights-of-way. It does not include private for-profit or commercial-scale wind or solar energy generating systems.

Public Works Facility means any publicly owned or occupied land, building, structure, system, plant or equipment constructed, erected, extended, enlarged, repaired, excavated or employed for the purpose of providing services to the public.

Q

R

Recycling Depot means a use that serves as a drop-off point for temporary storage and processing of recoverable resources such as newspapers, glassware, plastics, and metal cans. This use category does not include a salvage yard.

Rehabilitation / Healing Centre means a facility licensed or contracted to provide temporary occupancy in order to provide rehabilitation, healing, treatment or counseling services.

Residential Care Facility / Assisted Living Facility means the use of a building for the purpose of providing lodging, meals, care and supervision, or transitional services to persons not related by blood, marriage, or adoption to the operator nor to each other.

Retail means the use of a building or portion of a building where goods, wares, merchandise, or similar items are offered for sale directly to the public.

Retail, Small means a building or portion of a building where the retail use occurs in a space with a ground floor area less than 5,000 sq ft (465 sq m).

Retail, Large means a building or portion of a building where the retail use occurs in a space with a ground floor area equal to or greater than 5,000 sq ft (465 sq m).

S

Schools means an establishment which is privately or publicly supported or subsidized offering education, training, or instruction.

Seasonal Sales means the outside sale of seasonal merchandise, other than those sold at a farmer's market, such as Christmas trees, flags, kites, or arts and crafts.

Secondary means a use or structure that takes place on the same site as a principal use or structure that is not naturally and normally carried out as part of that principal use (e.g., a daycare in an office building).

Secondary Suite means a second dwelling unit detached from, attached to or within a principal building, that provides basic requirements for living, sleeping, cooking and sanitation.

Service Station means the servicing, washing, and repairing of vehicles and the sale of gasoline, other petroleum products and a limited range of vehicle parts and accessories. Service Stations may include Eating and Drinking Establishments.

Sewage Treatment Plants / Sites or Lagoons means a facility where wastewater or sewage is treated. It includes, but is not limited to, wastewater treatment plants, tanks, and lagoons.

Shipping Container means a prefabricated metal structure designed for use as a storage enclosure and which may be permanent or temporary in nature.

Site means a whole lot or block in a registered plan of subdivision, or the aggregate of all contiguous land described in a certificate of title or in more than one certificate of title provided they are in the same ownership.

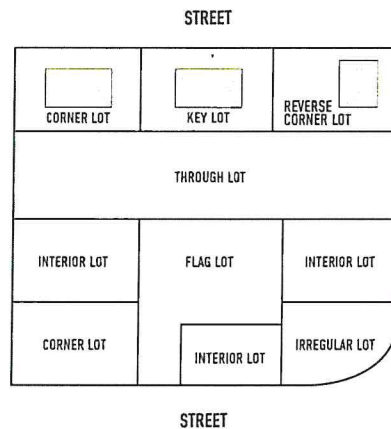

Site, Corner means a site situated at the intersection of two streets.

Site, Interior means a site other than a corner site or a through site.

Site, Through means a site having a pair of opposite site lines along two more-or-less parallel streets.

Site Area means the computed amount of gross land area contained within the site lines.

Site Coverage means the combined area of all buildings, structures, and paved surfaces on the site as a percentage of the site area, measured at the level of the lowest storey above the grade including all enclosed and insulated decks, sunrooms, porches, and verandas, but excluding seasonal non-insulated structures, open or covered, such as decks, screen porches or veranda, patios at grade, steps, uncovered walks, wheelchair ramps, cornices, eaves, and similar projections.

Site Line means one of the boundaries of a site.

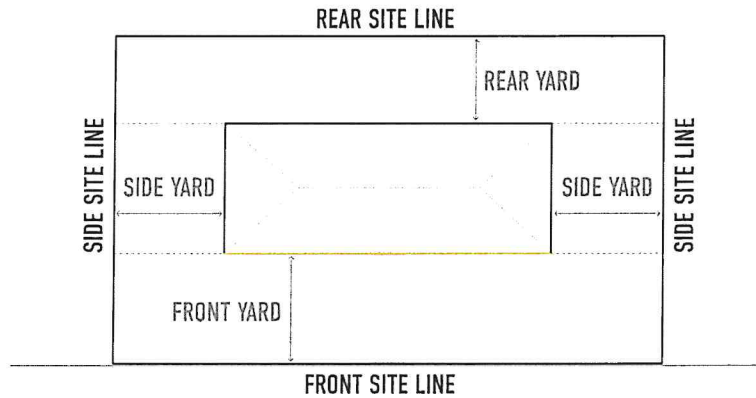

Site Line, Front means that boundary of a site along an existing or designated street. For a through site or corner site, the site lines along both streets shall be deemed front site lines. Where an irregular shaped site cannot have its site lines defined by this definition, the front site line shall be determined by the Designated Officer.

Site Line, Rear means that boundary of a site which is most nearly parallel to the front site line. Where an irregular shaped site cannot have its site lines defined by this definition, the rear site line shall be determined by the Designated Officer.

Site Line, Side means any boundary of a site which is not a front or rear site line.

Site Width means the horizontal distance between the side site lines, measured at right angles to the site depth at a point midway between the front and rear site lines, or 40 ft (3.7 m) from the front site line, whichever is the lesser.

Sleep Cabin means a building accessory to and subordinate to a Cottage Dwelling, that is designed to provide additional sleeping quarters for occasional guests of the owner and without kitchen facilities.

Solar Collector means a panel or other solar energy device with the primary purpose of gathering, storing, and distributing solar energy for electricity generation, space heating, space cooling, or water heating. Solar collectors can be ground anchored or wall-mounted and used for on-site electrical needs or commercial sale and distribution.

Special Event means a transportable group or aggregation or combination of rides, shows, performances, games, or concessions (i.e. carnival, circus, fair, concert, or similar event).

Stable means a building or land where horses are sheltered, fed, or kept for personal use.

Storey means that portion of any building which is situated between the top of any floor and the top of the floor next above it; and if there is no floor above it, that portion between the top of such floor and the ceiling above it but does not include a cellar.

Structure means a thing constructed or erected with a fixed location on or below the ground or attached to something with such a fixed location. It includes, but is not limited to, buildings, walls, fences, signs, billboards, light standards, and antennas.

T

Telecommunication Towers means outdoor equipment and structures required for the purposes of transmitting or receiving television, radio, microwave, radar, laser, or similar communications signals. These

facilities may include, but are not limited to: antennae, aerials, receiving dishes, transmission beacons, masts and towers.

Temporary Construction Trailer or Building means a portable structure or trailer used for the storage of construction materials and/or the offices or workspaces for construction managers or workers during the time a principal or accessory building is being constructed.

Theatre means an establishment devoted to showing motion pictures or dramatic, dance, musical or other live performances.

Trades and Contracting Facilities means a development used for the provision of building construction, landscaping, concrete, electrical, excavation, drilling, heating, plumbing, paving, road construction, sewer, or similar services of a construction nature which requires on-site storage space for materials, construction equipment or vehicles normally associated with the contractor service. Any sales, display, office, or technical support service areas shall be accessory to the principal Contractor service use only.

Trucking Establishments and Operations means land, buildings or structures used for the purpose of storing, servicing, repairing, or loading trucks, transportation trailers, and buses. This use class includes automotive repair, eating and drinking areas, retail sales, gas bars, and/or services stations, which can be considered accessory uses.

U

Urban Farm means a site or building where fruits, vegetables, and other plant products are grown, washed, or packaged for wholesale or retail sales. This use is distinct from animal keeping.

V

Veterinary Clinic means a development used for the care and treatment of animals where the veterinary services primarily involve outpatient care and minor medical procedures.

W

Waste Disposal Grounds / Sites means the land, structure, monitoring devices, and any other improvements on the land used for monitoring, treating, processing, storing or disposing of solid waste, leachate, or residuals from solid waste.

Waste Transfer Station means a facility where waste materials are collected in bulk containers for shipment to a landfill site, recycling facility, or other waste disposal facility.

Water Treatment Plants and Reservoirs means any facility, either publicly or privately owned and/or operated, where the quality of water is improved through filtering or chemical treatments for distribution.

Wind Energy Generating System means a device or group of devices such as wind chargers, windmills, or wind turbines, including towers, that convert wind energy into electrical energy for generation of power for sale by a public or commercial enterprise, including all associated accessory facilities.

Wholesale Businesses and Warehousing means a building or structure used for or intended to be used for the bulk storage and distribution facilities of goods, merchandise, or material, and/or a building intended for the wholesale storage or distribution of goods or products with associated retail sales.

Wildlife and Heritage Conservation Areas / Nature Reserves means land that has been designated by Provincial legislation for the protection and conservation of wildlife.

Wind Energy Generating System, Commercial means a wind energy generating system designed and built to provide electricity for commercial sale and distribution to the electricity grid.

Wind Energy Generating System, On-Site Use means a wind energy generating system intended to primarily serve the electrical needs of the on-site user or consumer (either behind the meter or off-grid) rather than to produce power for resale. Rooftop Wind Energy Generation Systems are a type of On-Site Use Wind Energy Generating System.

Wind Energy Generation System, Rooftop means a roof mounted wind turbine(s) and associated equipment for converting wind energy to power.

X

Y

Yard means an open area between the exterior wall of a building and the boundaries of the site on which it is located.

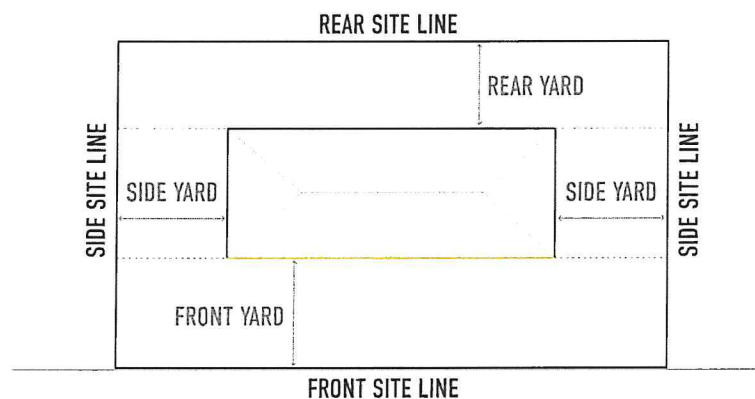

Yard, Corner Side means the yard extending along the side site line of a reverse corner site from the front yard to the rear yard, the depth of which is measured perpendicularly from the nearest wall of the principal building to the side site line.

Yard, Side means the yard extending along the side lot line from the front yard to the rear yard, the depth of which is measured perpendicularly from the nearest wall of the principal building to the side site line.

Yard, Rear means the yard extending along the full length of the rear site line, the depth of which is measured perpendicularly from the nearest wall of the principal building to the rear site line.

Yard, Required means the yard measured from a front, rear, or side site line towards the interior of the site, within which no building or any part of a building may be located, unless permitted herein.

SCHEDULE A: ZONING MAPS

The zones established in Part 3 shall apply within the boundaries of the zones shown on the maps in Schedule A following these rules of interpretation:

- a) Boundaries indicated as approximately following the centre-lines of streets, lanes, highways, rivers, or railway or public utility lines or rights-of-way shall follow such lines.
- b) Boundaries indicated as approximately following parcel limits as shown on a registered plan or by reference to the Dominion Government Survey shall follow such limits.

- c) If a street or lane or railway or public utility right-of-way ('the feature') shown on the Zoning Map is lawfully closed, the land formerly comprising the feature shall be included within the zone of the land which surrounds it. If the said feature included a zone boundary on its centerline, then the zone boundary shall be the former centreline.

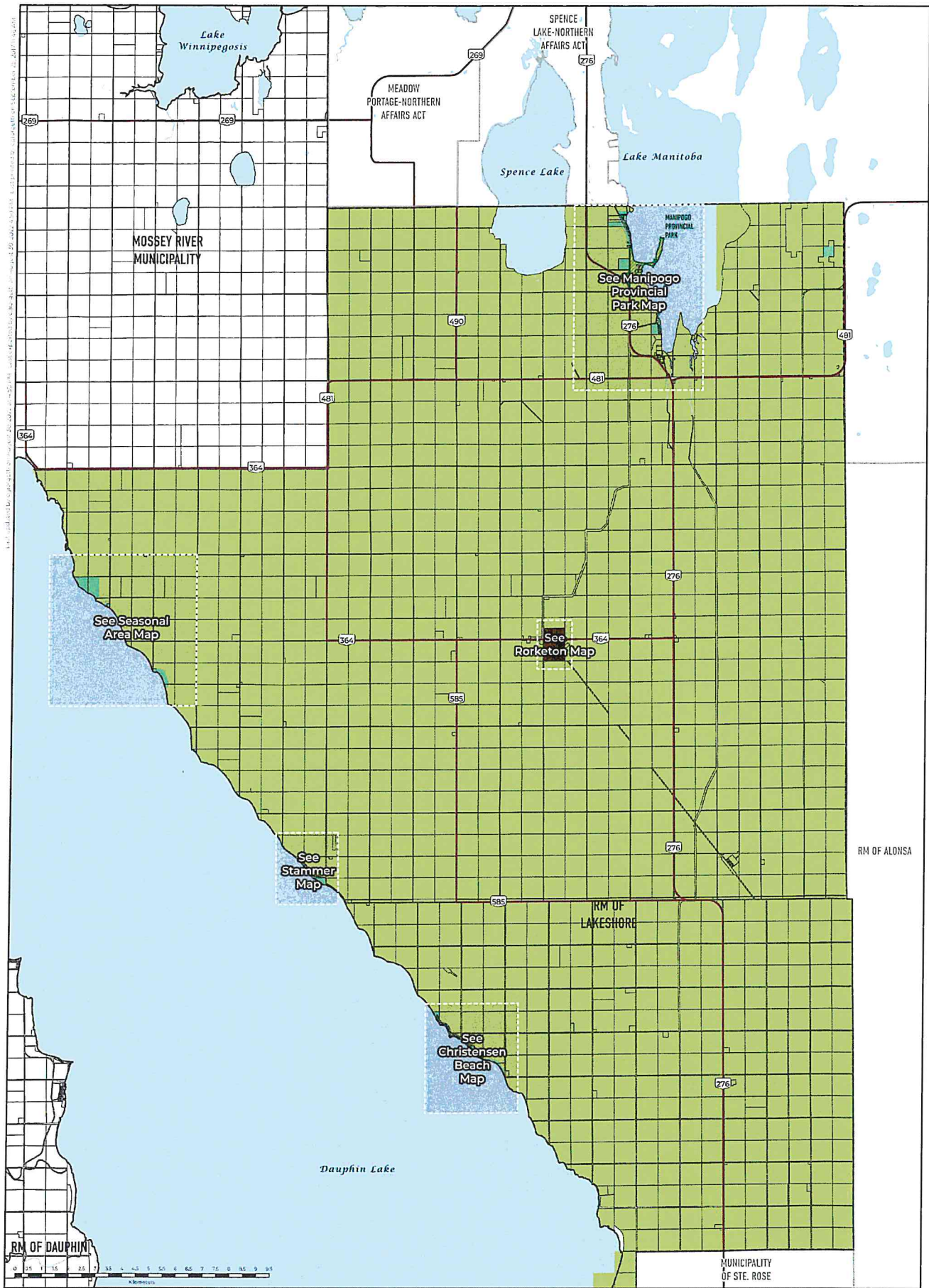

URBAN SYSTEMS

Project #: 5076.0001.01
 Author: LK
 Checked: RS
 Status: DRAFT
 Revision: A
 Date: 2022/8/30

Coordinate System:
 NAD 1983 UTM Zone 14N

Data Sources:
 - Province of Manitoba (2021)

Scale:
 1:65,000
 (When plotted at 22"x34")



The accuracy & completeness of information shown on this drawing is not guaranteed. It will be the responsibility of the user of the information shown on this drawing to locate & establish the precise location of all existing information whether shown or not.

Legend

Planning District	General Development Zone (GD)
Municipal Boundary	Open Space/Recreation Zone (OR)
Assessment Roll	Residential General (RG)
Zoning Bylaw	Residential Rural (RR)
ZONE_NAME_2022	Seasonal Recreation Area (SR)
Agricultural General Zone (AG)	Wildlife Management Area (WMA)
Agricultural Limited Zone (AL)	Waterbody, 2
Commercial Industrial Zone (CI)	

RM of Lakeshore (North) Zoning

SPENCE
LAKE-NORTHERN
AFFAIRS ACT

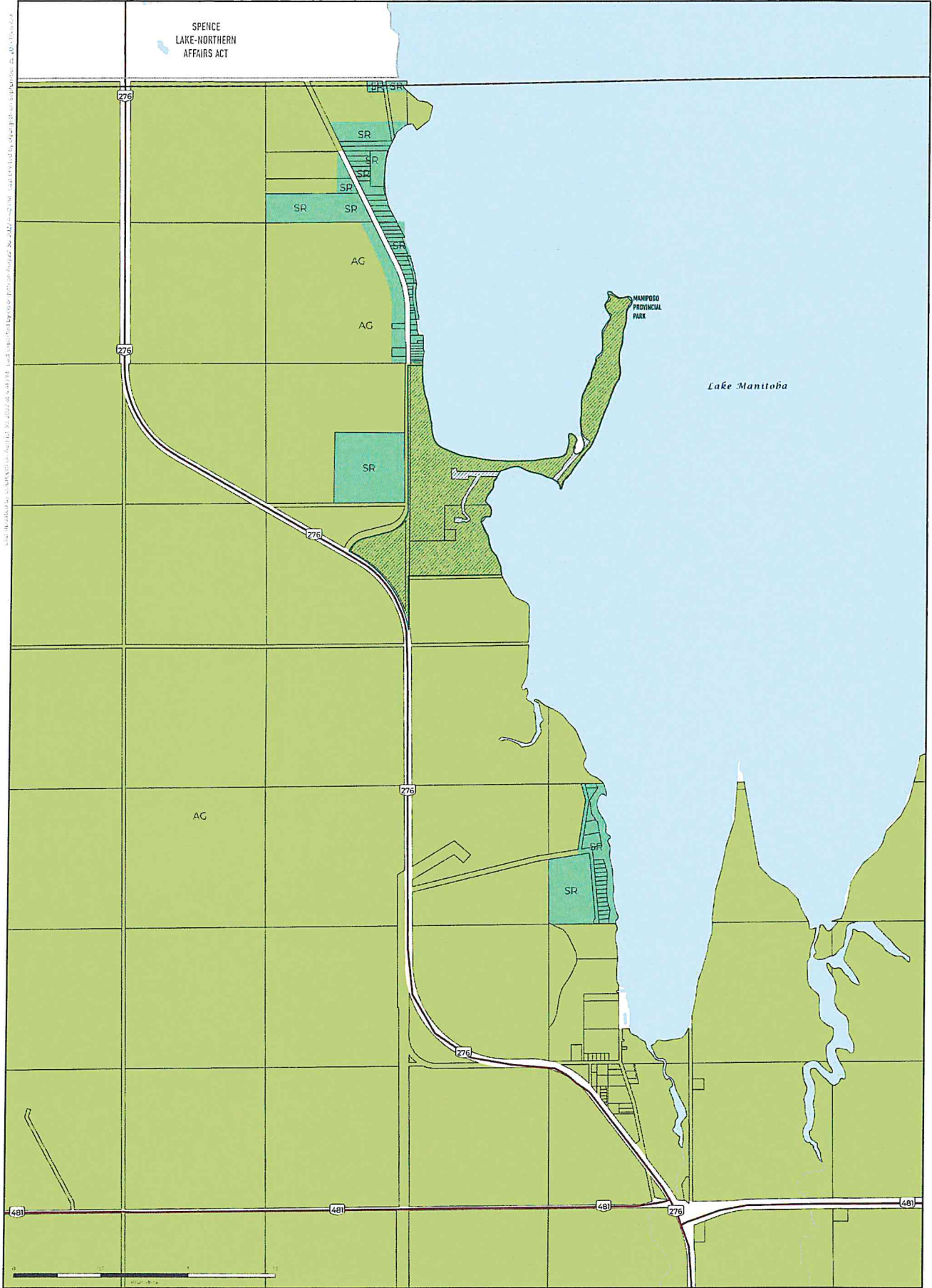

URBAN SYSTEMS

Project #: 5076.0001.01
 Author: LK
 Checked: RS
 Status: DRAFT
 Revision: A
 Date: 2022 / 8 / 30

Coordinate System:
NAD 1983 UTM Zone 14N

Scale:
1:10,000
(When plotted at 22"x34")

Data Sources:
- Province of Manitoba (2021)

The accuracy & completeness of information shown on this drawing is not guaranteed. It will be the responsibility of the user of the information shown on this drawing to locate & establish the precise location of all existing information whether shown or not.

Legend

Planning District	General Development Zone (GD)
Municipal Boundary	Open Space/Recreation Zone (OSR)
Accommodation Right	Residential General (RG)
Zoning Bylaw	Residential Rural Zone (RR)
ZONE_NAME_2022 Agricultural General Zone (AG)	Seasonal Recreation Zone (SR)
Agricultural Limited Zone (AL)	Wildlife Management Area (WMA)
Commercial Industrial Zone (CI)	waterbody_2

Manipogo Provincial Park Zoning

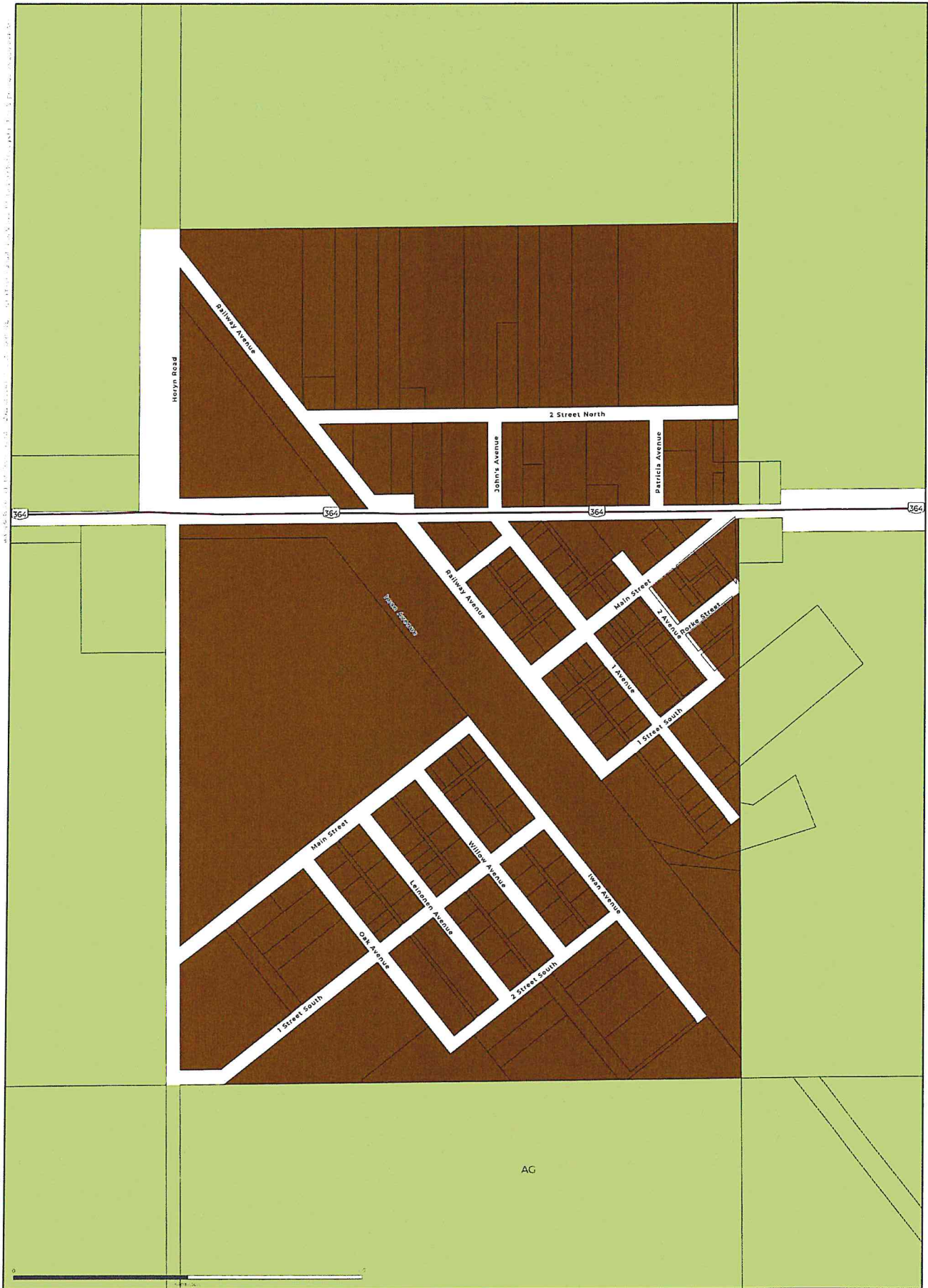

URBAN SYSTEMS

Project #: 5076.000101
 Author: LK
 Checked: RS
 Status: DRAFT
 Revision: A

Coordinate System:
 NAD 1983 UTM Zone 14N

Data Sources:
 - Province of Manitoba (2021)

Scale:
 1:2,500
 (When plotted at 22"x34")



- Legend**
- Assessor's Plot
 - Zoning Overlay
 - ZONE 14N_E_2022
 - Agricultural General Zone (AG)
 - Agricultural Limited Zone (AL)
 - Commercial Industrial Zone (CI)
 - General Development Zone (GD)
 - Open Space/Recreation Zone (OS)
 - Residential General (RC)
 - Residential Rural Zone (RR)
 - Seasonal Recreation Zone (SR)
 - Wildlife Management Area (WMA)
 - Waterbody, 2

Rorketon Zoning

The accuracy & completeness of information shown on this drawing is not guaranteed. It will be the responsibility of the user of the information shown on this drawing to locate & establish the precise location of all existing

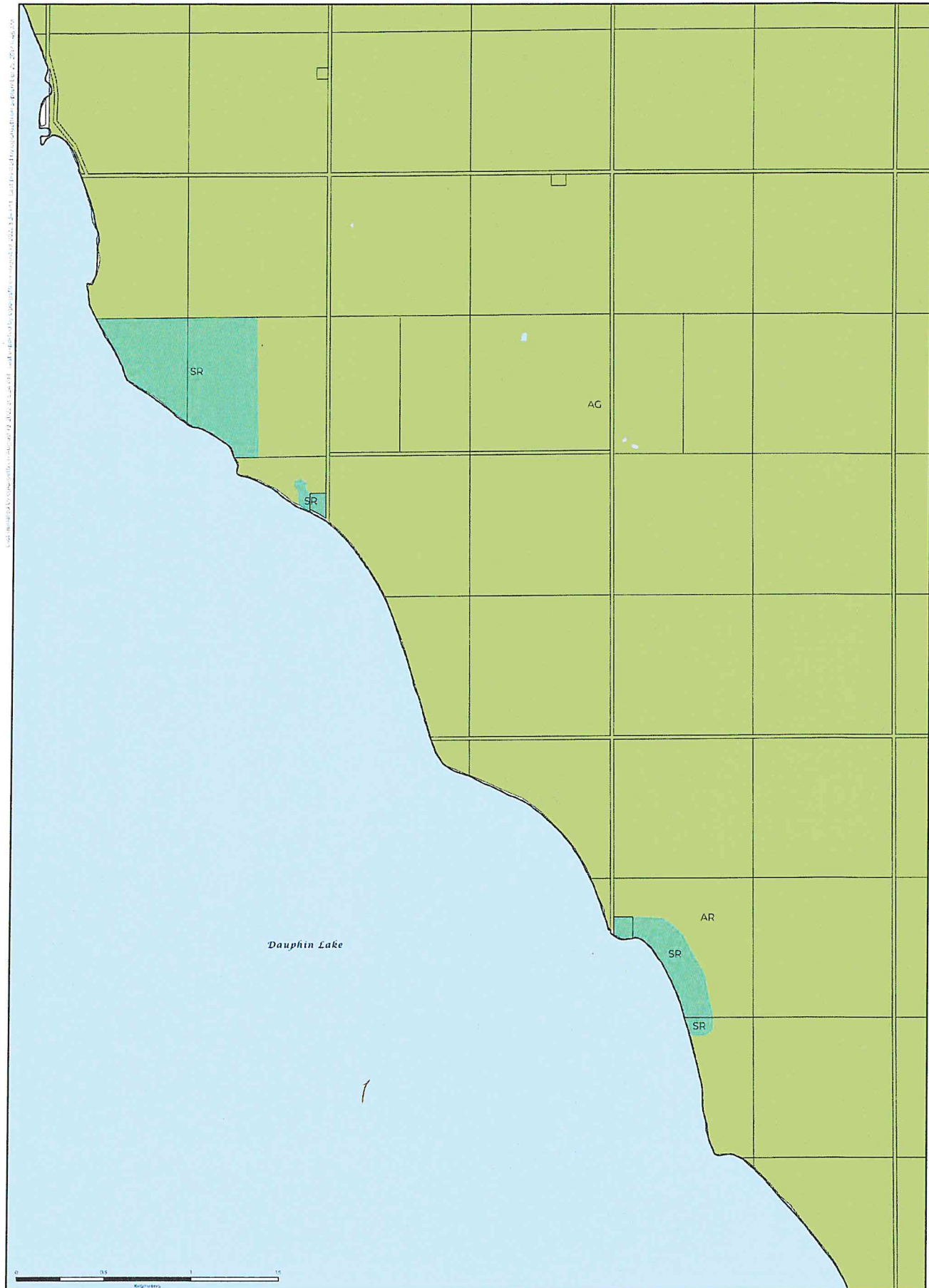

Project #: 5076.0001.01
 Author: LK
 Checked: RS
 Status: DRAFT
 Revision: A

Coordinate System:
 NAD 1983 UTM Zone 14N
 Scale:
 1:10,000
 Data Sources:
 - Province of Manitoba (2021)
 (When plotted at 22"x34")



- Legend**
- Planning District
 - Municipal Boundary
 - Assessment Rpt
 - Zoning By-law
 - ZONE_NAME_2022
 - Agricultural General Zone (AG)
 - Agricultural Limited Zone (AL)
 - Commercial Industrial Zone (CI)
 - General Development Zone (GD)
 - Open Space/Recreation Zone (OSR)
 - Residential General (RG)
 - Residential Rural Zone (RR)
 - Seasonal Recreation Zone (SR)
 - Wildlife Management Area (WMA)
 - Wetbody, 2

Seasonal Area Zoning

The accuracy & completeness of information shown on this drawing is not guaranteed. It will be the responsibility of the user of the information shown on this drawing to locate & establish the precise location of all existing



URBAN SYSTEMS

Project #: 5076.0001.01
 Author: LK
 Checked: RS
 Status: DRAFT
 Revision: A

Coordinate System:
 NAD 1983 UTM Zone 14N

Data Sources:
 - Province of Manitoba (2021)

Scale:
 1:4,500
 (When plotted at 22"x34")



Legend

- Planning District
- Municipal Boundary
- Assessment Roll
- Zoning Bylaw
- ZONE_NAME_2022
- Agricultural General Zone (AG)
- Agricultural Limited Zone (AL)
- Commercial Industrial Zone (CI)
- General Development Zone (GD)
- Open Space/Recreation Zone (OR)
- Residential General (RG)
- Residential Rural Zone (RR)
- Search and Recreation Zone (SR)
- Wildlife Management Area (WMA)
- waterbody_2

Stammer Zoning

The accuracy and completeness of information shown on this drawing is not guaranteed. It will be the responsibility of the user of the information shown on this drawing to locate & establish the precise location of all existing

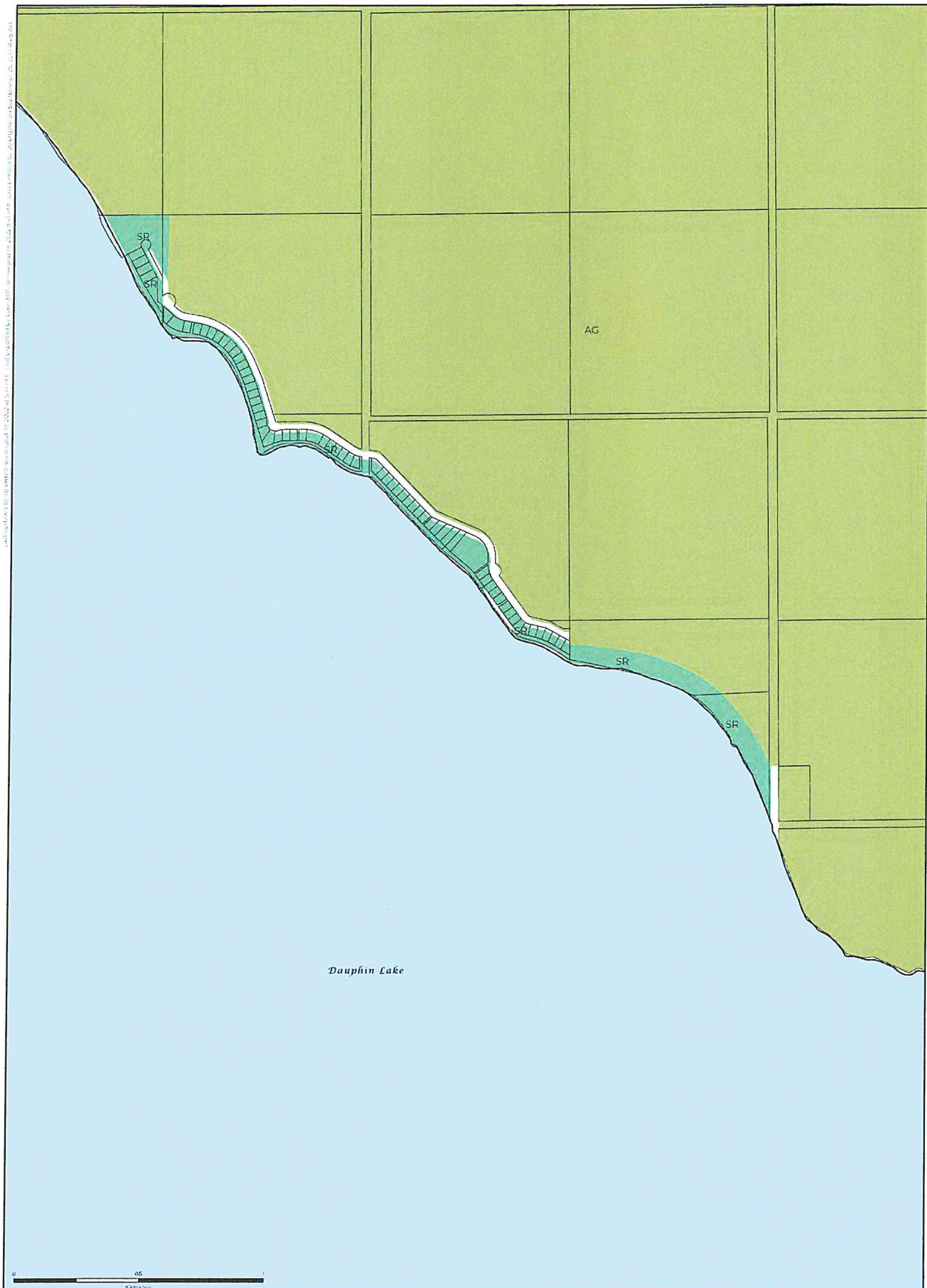

URBAN SYSTEMS

Project #: 5076.0001.01
 Author: LK
 Checked: RS
 Status: DRAFT
 Revision: A

Coordinate System:
 NAD 1983 UTM Zone 14N

Data Sources:
 - Province of Manitoba (2021)

Scale:
 1:7,000
 (When plotted at 22"x34")

The accuracy & completeness of information shown on this drawing is not guaranteed. It will be the responsibility of the user of the information drawn on this drawing to locate & establish the precise location of all existing

Legend

Planning District	General Development Zone (GD)
Municipal Boundary	Open Space/Recreation Zone (OSR)
Accommodation (A)	Residential General (RG)
Zoning By-law	Residential Rural Zone (RR)
ZONE_NAME_2022	Special Use Recreation Zone (SR)
Agricultural General Zone (AG)	Wildlife Management Area (WMA)
Agricultural Limited Zone (AL)	Waterbody_2
Commercial Industrial Zone (CI)	

Christensen Beach Zoning

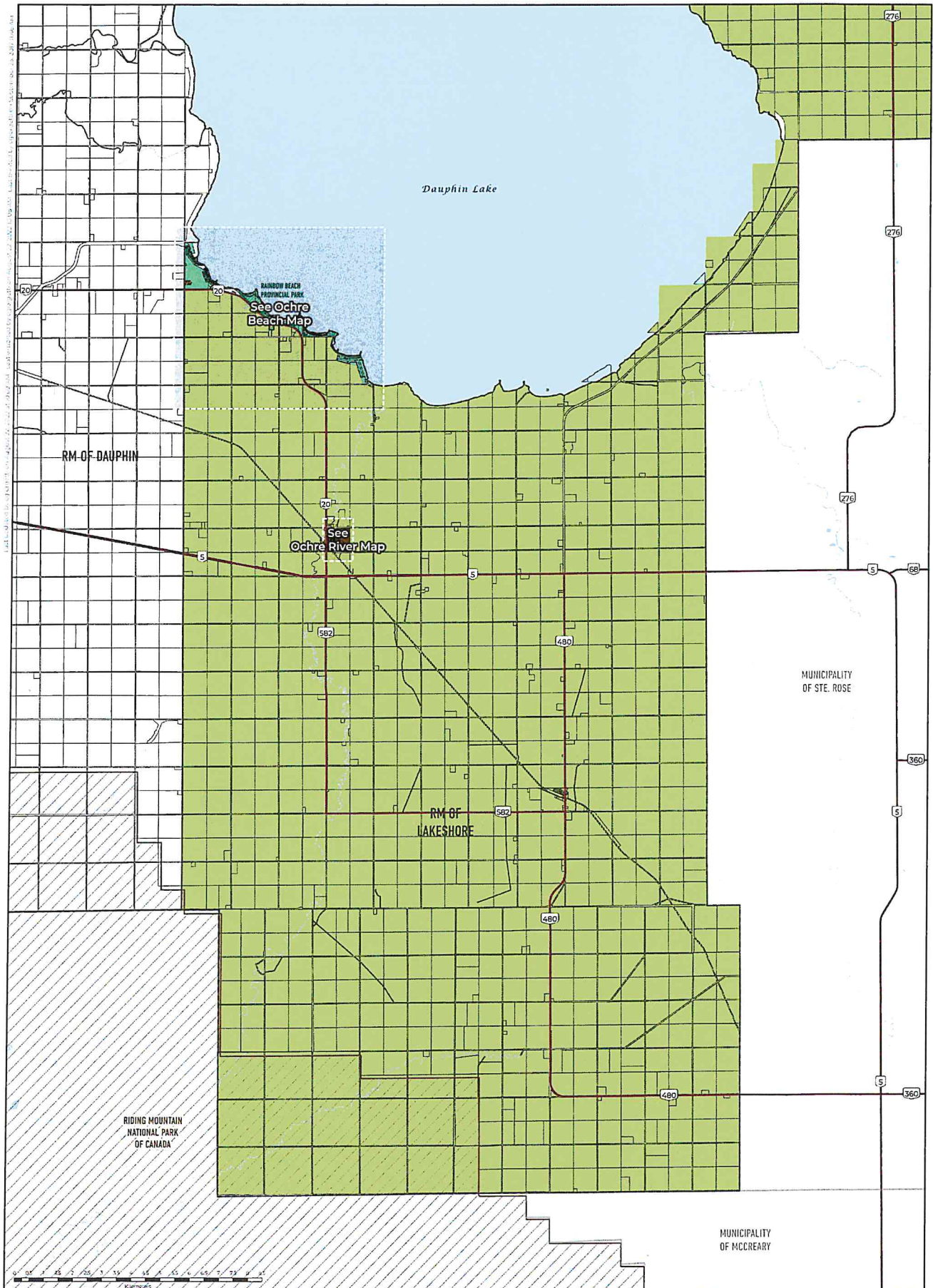

URBAN SYSTEMS

Project #: 5076.0001.01
 Author: LK
 Checked: RS
 Status: DRAFT
 Revision: A

Coordinate System:
 NAD 1983 UTM Zone 14N

Scale:
 1:60,000
 (When plotted at 22"x34")

Data Sources:
 - Province of Manitoba (2021)

The accuracy & completeness of information shown on this drawing is not guaranteed. It will be the responsibility of the user of the information shown on this drawing to locate & establish the precise location of all existing

Legend

Planning Districts	General Development Zone (GD)
Municipal Boundary	Open Space Recreation Zone (OSR)
Assessment Roll	Residential General (RG)
Zoning Overlay	Residential Rural Zone (RR)
ZONE_NAME_2022	Seasonal Recreation Zone (SR)
Agricultural General Zone (AG)	Wildlife Management Area (WMA)
Agricultural Limited Zone (AL)	Waterbody, 2
Commercial Industrial Zone (CI)	

RM of Lakeshore (South) Zoning

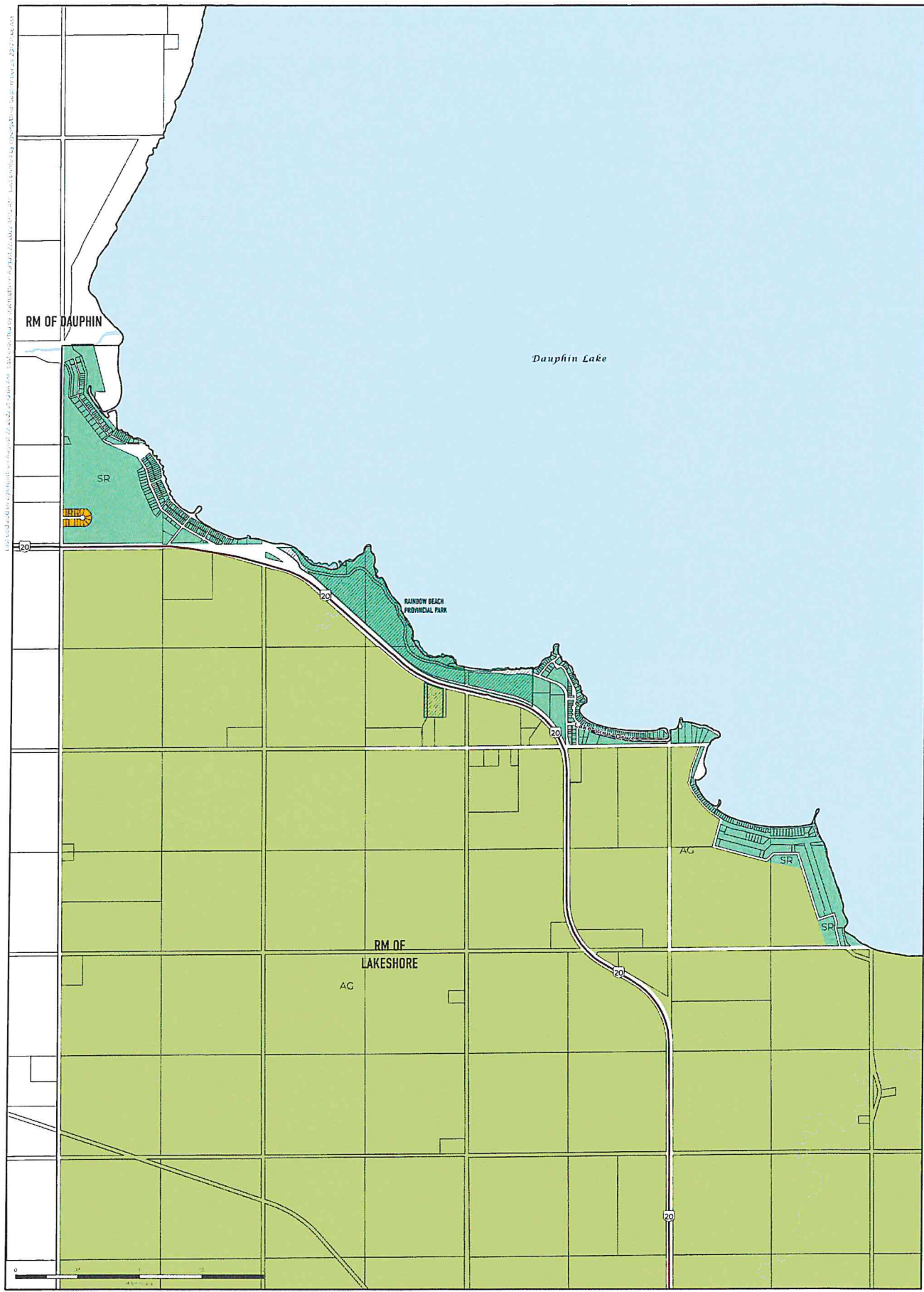

URBAN SYSTEMS

Project #: 5076.0001.01
 Author: LK
 Checked: RS
 Status: DRAFT
 Revision: A
 Date: 2022 / 8 / 22

Coordinate System:
 NAD 1983 UTM Zone 14N

Data Sources:
 - Province of Manitoba (2021)

Scale:
 1:14,000
 (When plotted at 22"x34")



- Legend**
- Planning District
 - Municipal Boundary
 - Assessment Rail
 - Zoning Overlay
 - ZONE NAME 2022
 - Agricultural General Zone (AG)
 - Agricultural Limited Zone (AGC)
 - Commercial Industrial Zone (CI)
 - General Development Zone (GD)
 - Open Space/Recreation Zone (OSR)
 - Residential General (RG)
 - Residential Rural Zone (RR)
 - Seasonal Recreation Zone (SR)
 - Wildlife Management Area (WMA)
 - Waterbody_2

Ochre Beach
 Zoning

The accuracy & completeness of information shown on this drawing is not guaranteed. It will be the responsibility of the user of the information shown on this drawing to verify & establish the precise location of all existing information whether shown or not.

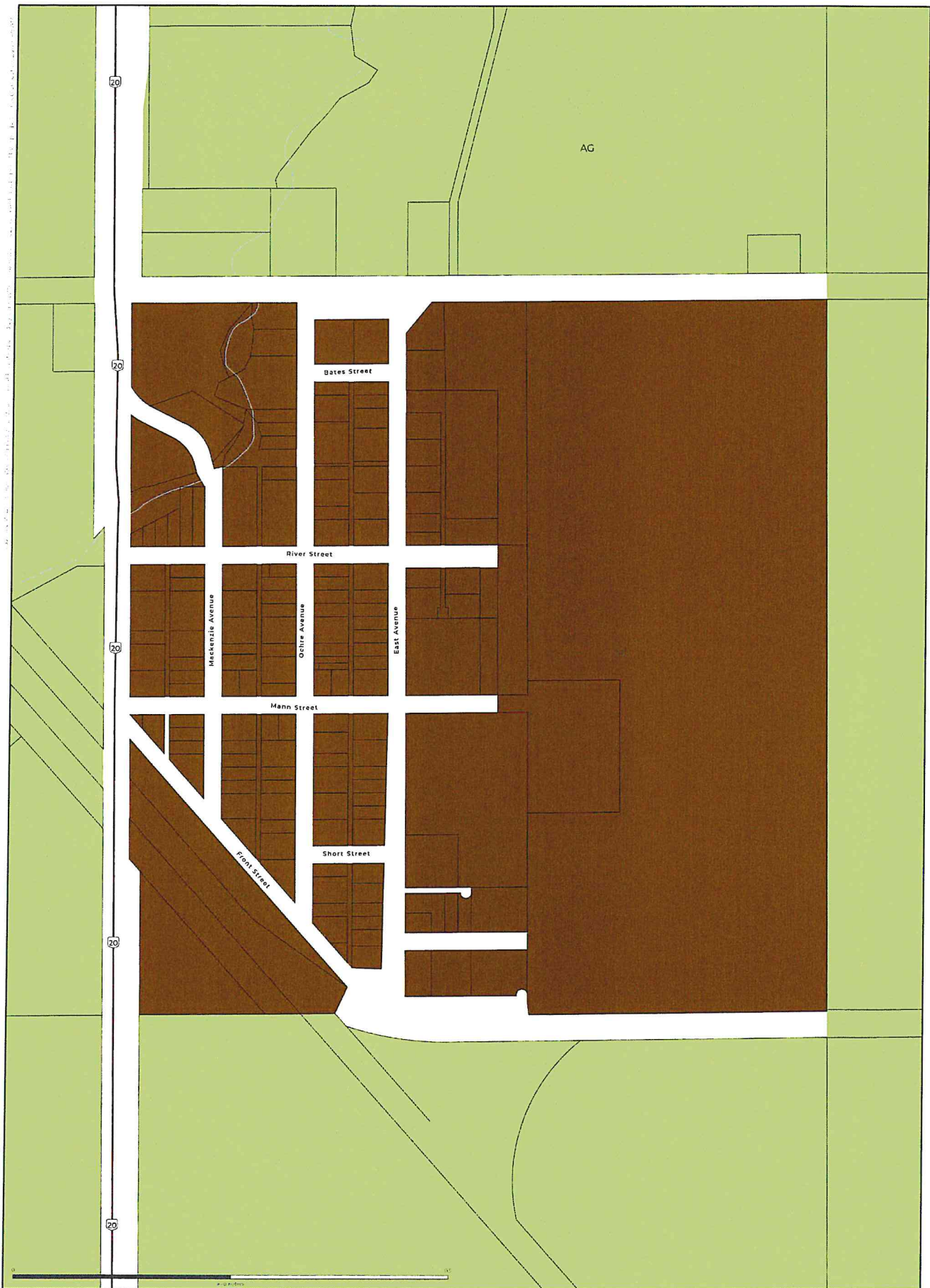

URBAN SYSTEMS

Project #: 5076.0001.01
 Author: LK
 Checked: RS
 Status: DRAFT
 Revision: A
 Date: 2022 / 8 / 22

Coordinate System:
 NAD 1983 UTM Zone 14N

Scale:
 12,000
 (When plotted at 22"x34")



Data Sources:
 - Province of Manitoba (2021)

The accuracy & completeness of information shown on this drawing is not guaranteed. It will be the responsibility of the user of the information shown on this drawing to secure & establish the precise location of all existing information if it is not shown or not.

- Legend**
- Planning District
 - Municipal Boundary
 - Assessment Roll
 - Zoning By-law
 - ZONE, N/A/M/S, 2022
 - Agricultural General Zone (AG)
 - Agricultural Limited Zone (AL)
 - Commercial Industrial Zone (CI)
 - General Development Zone (GD)
 - Open Space/Recreation Zone (OSR)
 - Residential General (RG)
 - Residential Rural Zone (RR)
 - Seasonal Recreation Zone (SR)
 - Wildlife Management Area (WMA)
 - Waterbody, 2

Ochre River
 Zoning